

EN156M-144-395/400/405/410/415W







High Efficiency PERC Monocrystalline Solar Module 144 Half-Cell Series

ABOUT ECONESS ENERGY

Established in 2009 by Jiangsu Huadong Group (founded in 1997), Econess Energy is a world's leading solution provider for solar energy. With annual production capacity of 800MW cells and 1.2GW modules. Econess Energy now distributes its PV products to over 36 countries with cumulative module shipment of 4GW. As a strong, bankable partner, we are committed to building strategic, mutually beneficial collaboration with installers and developers.



KEY FEATURES

-  **Maximize limited space**
Half cell technology (low Rs) combine with PERC, more internal reflection, maximum power output 415W
-  **Significantly reduce the hot spot effect**
Unique circuit design significantly reduces hot spot temperature and power loss
-  **IP67 junction box**
The highest waterproof level
-  **Excellent Anti-PID performance**
2 times of industry standard Anti-PID test by TUV
-  **Lower temperature coefficients**
Enhance power generation
-  **Certified to withstand the most challenging environmental conditions**
2400 Pa wind load · 5400 Pa snow load · 25mm hail stones at 82 km/h

SYSTEM & PRODUCT CERTIFICATES

- IEC 61215 / IEC 61730 / UL 1703
- ISO 9001 : 2015 Quality Management System
- ISO 14001 : 2015 Environment Mangement System
- OHSAS 18001 : 2007 Occupational Health and Safety Management System



QUALITY WARRANTY

Econess Energy guarantees that defects will not appear in materials and workmanship defined by IEC61215, IEC61730 or UL1703 under normal installation, use and maintenance as specified in Econess Energy's installation manual for 10 years from the warranty starting date.

PERFORMANCE WARRANTY

Monocrystalline Solar Module

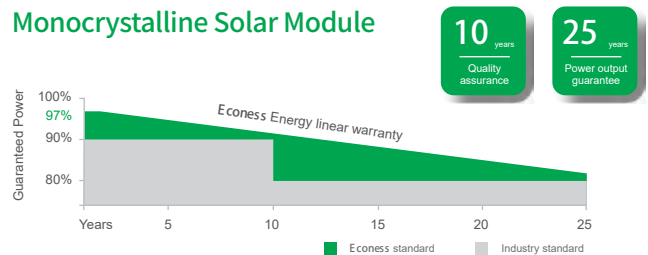

ELECTRICAL PARAMETERS

Performance at STC (Power Tolerance 0 - +3%)

Maximum Power(Pmax/W)	395	400	405	410	415
Operating Voltage (Vmpp/V)	40.94	41.20	41.47	41.72	41.98
Operating Current(Imp/A)	9.66	9.72	9.78	9.87	9.93
Open-Circuit Voltage (Voc/V)	49.55	49.79	50.04	50.31	50.55
Short-Circuit Current(Isc/A)	10.22	10.31	10.39	10.47	10.55
Module Efficiency η_m (%)	18.44	18.67	18.90	19.14	19.37

Performance at NMOT

Maximum Power(Pmax/W)	293	297	300	304	309
Operating Voltage (Vmpp/V)	37.62	38.11	38.35	38.59	38.81
Operating Current(Imp/A)	7.76	7.82	7.88	7.96	8.02
Open-Circuit Voltage (Voc/V)	45.92	46.18	46.42	46.69	46.95
Short-Circuit Current(Isc/A)	8.22	8.82	8.34	8.39	8.45

STC: Irradiance 1000W/m², Cell Temperature 25°C, Air Mass AM1.5 NMOT: Irradiance at 800W/m², Ambient Temperature 20°C, Wind Speed 1m/s

MECHANICAL SPECIFICATION

Cell Type	Half-Cell · Mono PERC · 5BB
Cell Dimensions	6 inch (161.7 x 161.7 mm)
Cell Arrangement	144 [2 x (12 x 6)]
Weight	25 kg (55.12 lb)
Module Dimensions	2080 x 1030 x 40 mm (81.89 x 40.55 x 1.57inch)
Cable Length	300 mm (11.81 inch)
Cable Cross Section Size	4 mm ² (0.006 sq.in)
Front Glass	3.2 mm High Transmission, Tempered Glass
No.of Bypass Diodes	3/6
Packing Configuration (1)	27pcs/Pallet, 594pcs/40hq
Packing Configuration (2)	27pcs+4pcs/Pallet, 638pcs/40hq
Frame	Anodized Aluminium Alloy
Junction Box	IP67

I-V CURVE

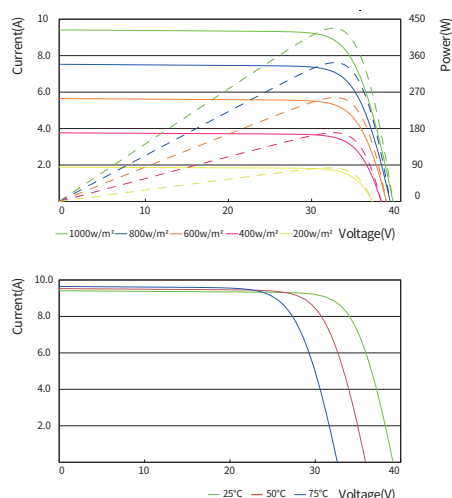

OPERATING CONDITIONS

Maximum System Voltage	1000V (IEC) DC / 1500V (IEC) DC
Operating Temp	-40°C ~ +85°C
Maximum Series Fuse	15 A / 20 A
Static Loading	5400 Pa
Conductivity at Ground	≤ 0.1Ω
Safety Class	II
Resistance	≥ 100MΩ
Connector	MC4 Compatible

TEMPERATURE COEFFICIENT

Temperature Coefficient(Pmax)	-0.39%/°C
Temperature Coefficient(Voc)	-0.30%/°C
Temperature Coefficient(Isc)	+0.05%/°C
NMOT	45 ± 2°C

TECHNICAL DRAWINGS (mm)

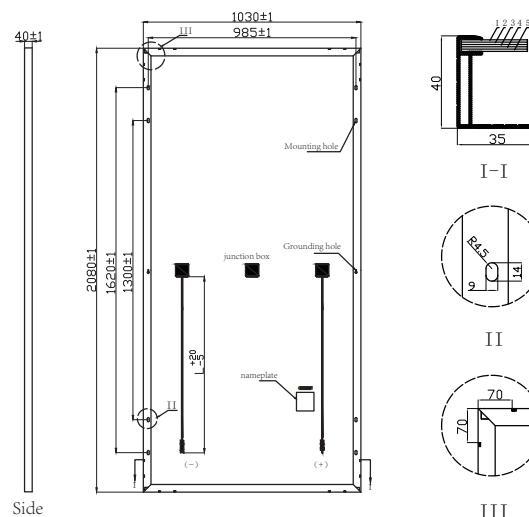

Econess Energy Co., Ltd.

58 Haida Road, Huashi, Jiangyin, Jiangsu, P.R. China 214421 +86-510-86076868 sales@eco-pv.com www.eco-pv.com

* This is preliminary datasheet and for reference only. The specifications and key features contained in this datasheet may deviate slightly from our actual products due to the on-going innovation and product enhancement. Econess Energy reserves the right to make necessary adjustment to the information described herein at any time without further notice.