

GFMJ-1200

GEL Battery (2V1200Ah)

Features

- Gel battery uses corrosion resistant high-tin alloy grids to enhance corrosion resistance of plates, effectively improve the life of float charging.
- High-tight assembly process design and assorted equipments greatly improved batteries charging acceptance and deep discharging recovery performance.
- Precise acid vacuum injection method, advanced, environmental formation technology, which effectively guarantee the consistency of the batteries
- The terminal adopts proprietary technology of sealing structure and high-temperature curing epoxy adhesive to ensure batteries safety and reliability

Dimensions

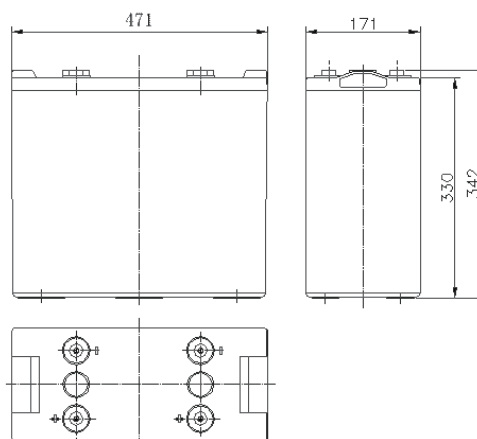

Specifications

Battery Type	GEL Battery
Nominal Voltage	2V
Nominal Capacity	1200Ah (10hr, 1.8V, 25°C)
Dimension(L*W*H)	471(mm)*171(mm)*342(mm)
Designed Life(Float charge, 25°C)	10 Years
The reference weight	68.5kg
Operation Ambient Temperature	-25°C~50°C
Optimal Ambient Temperature	20°C~25°C
Self-discharge Residual Capacity	After 90days storage at 25°C, the residual capacity≥90%
Container Material	ABS
Terminal(mm)	Φ20, M8
The Reference Dimension for Installation(See Pic, L*W*H)	48V: 1195×1052×1053mm



Follow us



www.renosola.com

TECHNICAL GRAPHS

DISCHARGE CHARACTERISTIC CURVE

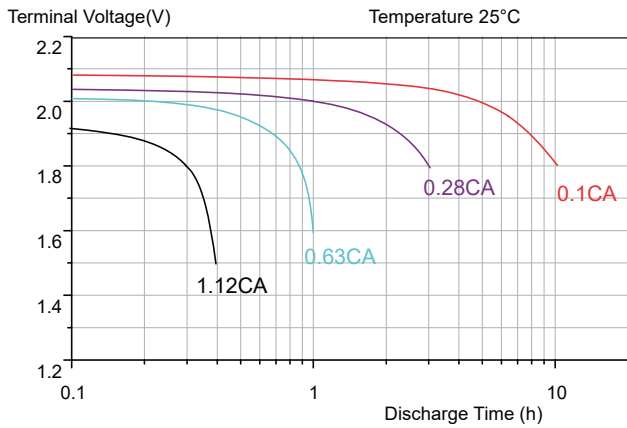

Temperature Vs. Capacity

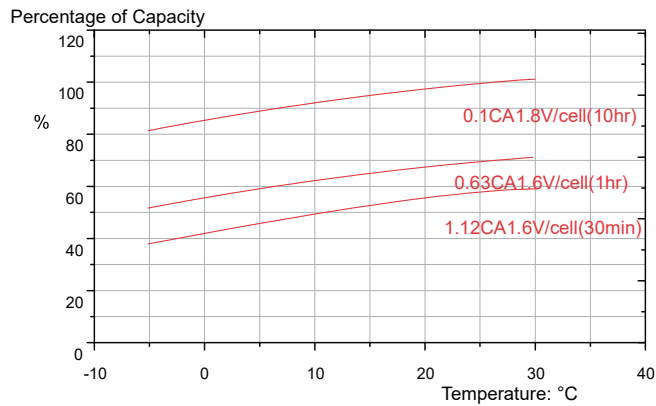

Self-discharge Characteristics

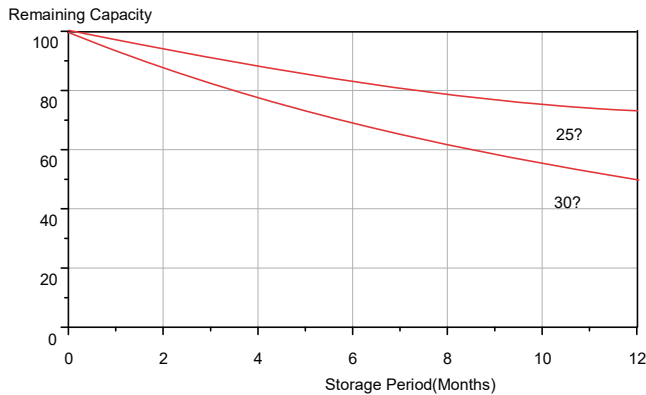

Discharge Current and Discharge Final Voltage

Discharge Current	0.1C	0.16C	0.23C	0.6C	3C
Final Voltage(V)	1.80	1.75	1.70	1.60	1.30

CHARGE CHARACTERISTIC CURVE

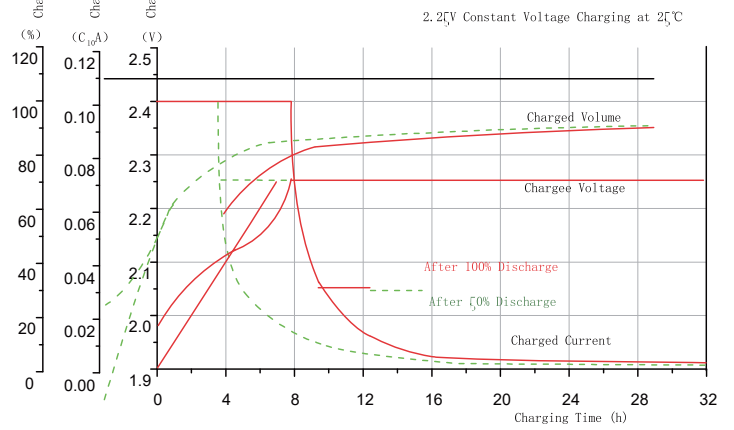

Accelerated Life Characteristic

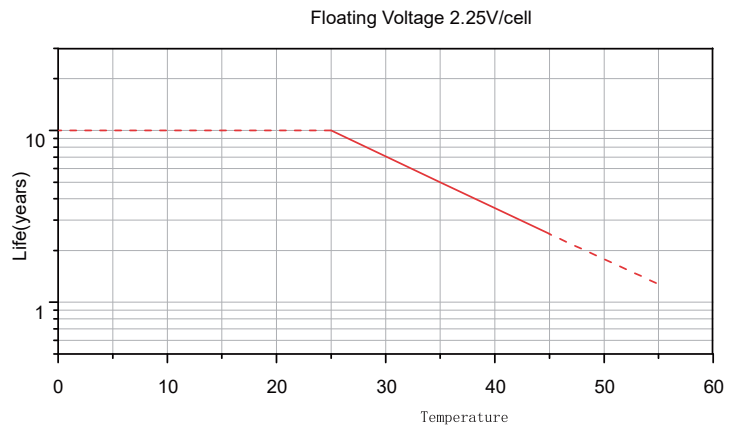

48V System Battery Set

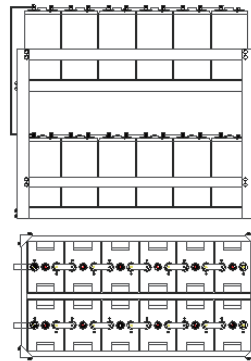

48V Horizontal Battery Set

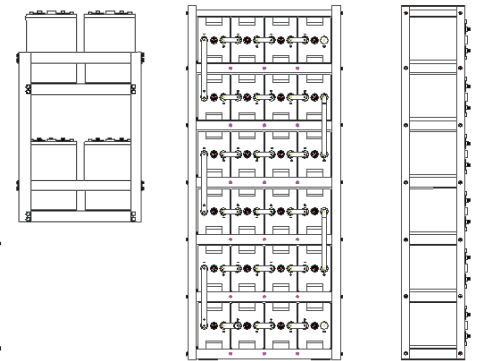

Charge Method

Type	Voltage(V)	Temperature compensation coefficient	Charge Current(A)
Cycle Charge	2.30~2.40	-4mV/°C	0.1C~0.25C
Float Charge	2.23~2.27	-3mV/°C	

Follow us

