

## General Feature

deep cycle battery

- Absorbent Glass Mat(AGM) technology for efficient gas recombination of up to 99% and freedom from electrolyte maintenance or water adding.
- Not restricted for air transport-complies with IATA/ICAO Special Provision A67.
- UL-recognized component.
- Can be mounted in any orientation.
- Computer designed lead, calcium tin alloy grid for high power density.
- Long service life, float or cyclic applications.
- Maintenance-free operation.
- Low self discharge.



## SPECIFICATION

Nominal voltage .....	2V
Number of cell .....	1
Length(mm/inch) .....	242/9.53
Width(mm/inch) .....	173/6.81
Height(mm/inch) .....	330/13.0
Total Height(mm/inch) .....	365/14.4
Approx. Weight(kg/lbs) .....	32/70.5

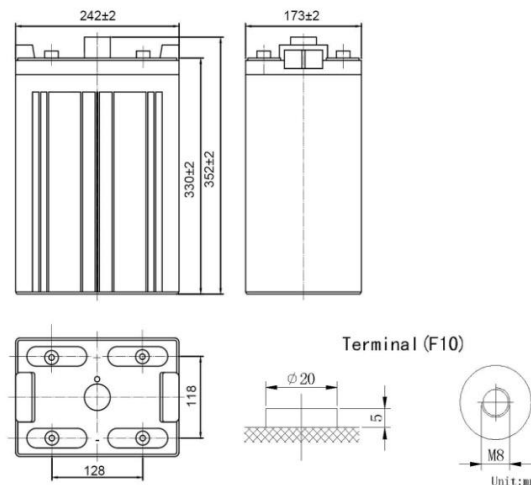

Total height with removable cover:367

## Battery Construction

Component	Positive plate	Negative plate	Container	Cover	Safety valve	Terminal	Separator	Electrolyte
Raw material	Lead dioxide	Lead	ABS	ABS	Rubber	Copper	Fiberglass	Sulfuric acid

## Performance Characteristics

Capacity 77°F(25°C)	10 hours rate(50A 1.80V)	500Ah
	5 hours rate(88A 1.75V)	440Ah
	3 hours rate(126A 1.70V)	378Ah
	1 hour rate(300A 1.60V)	300Ah
Internal Resistance	Full charged battery 77°F(25°C):0.8mΩ	
Capacity affected by Temperature (10 hour rate)	104°F(40°C)	102%
	77°F(25°C)	100%
	32°F(10°C)	85%
	5°F(-15°C)	65%
Self-Discharge 68°F(20°C)	Capacity after 3 month storage	90%
	Capacity after 6 month storage	80%
	Capacity after 12 month storage	60%
Max discharge current77°F(25°C):2000A(5S)		
Charge (Constant Voltage)	Float:2.25 to 2.30V/77°F/(25°C)	
	Cycle:2.35 to 2.45V/77°F/(25°C) Max Current:100A	

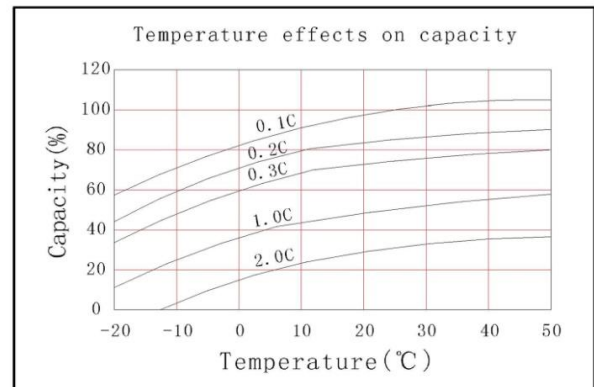
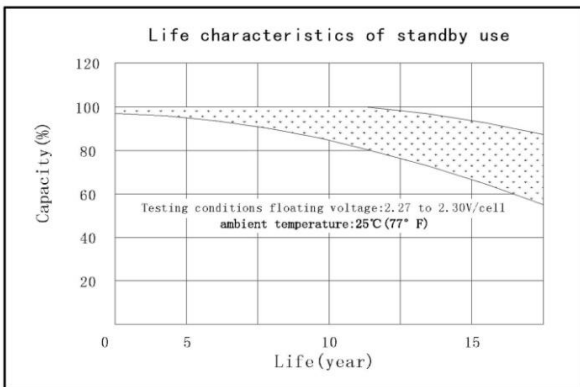
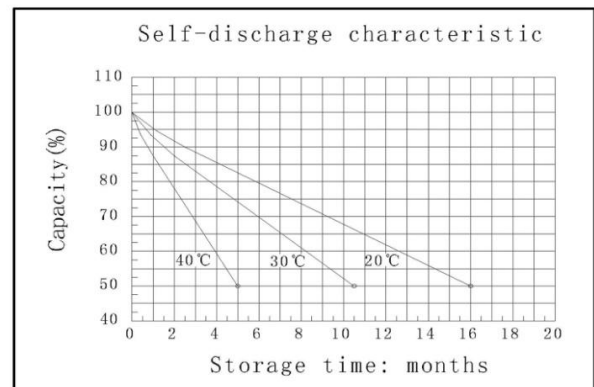
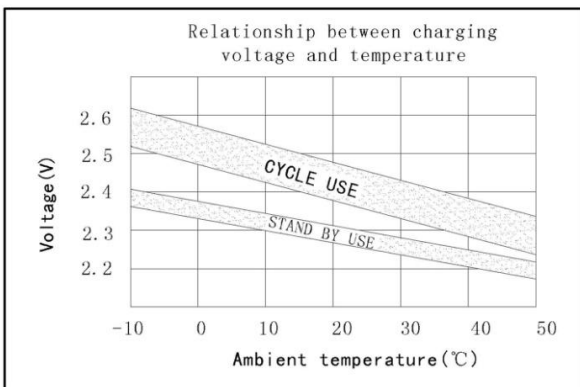
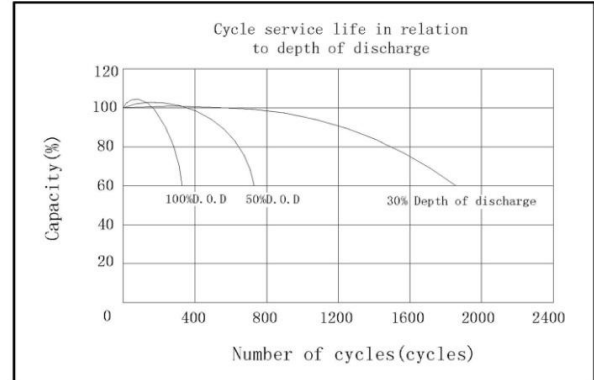
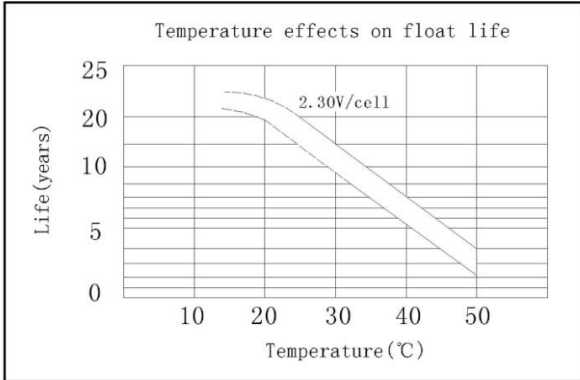
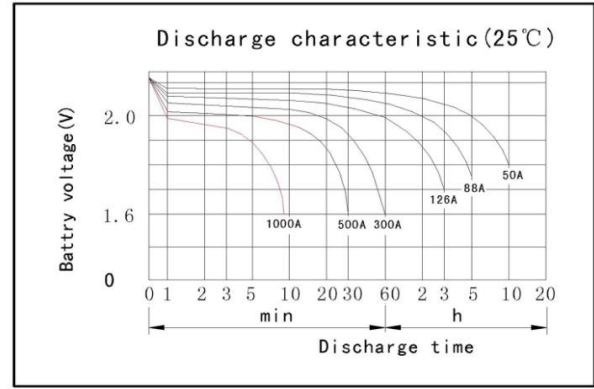
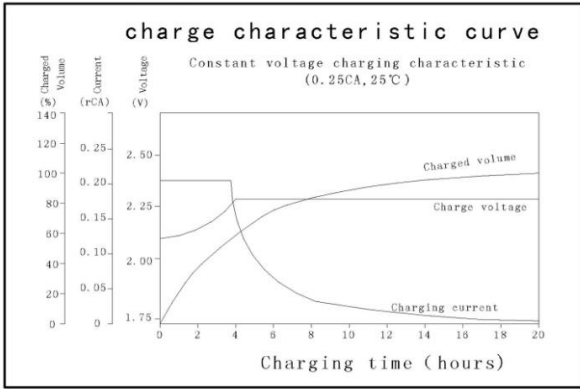

**Discharge Constant Current (Amperes at 77° F 25 °C)**

End Point Volts/Cell	5min	10min	15min	30min	45min	1h	3h	5h	10h
1.60V		937	711	500	383	300	134	94.5	53.8
1.65V		888	677	480	368	290	130	92.5	53.1
1.70V		837	642	460	352	278	126	90.5	52.2
1.75V		785	606	432	335	266	122	88.0	51.2
1.80V		733	570	405	317	253	115	85.0	50.0

(Note)The above characteristics data are average values obtained Within three charge/discharge cycles not the minimum values.

**Discharge Constant Power (watts at 77° F 25 °C)**

End Point Volts/Cell	5min	10min	15min	30min	45min	1h	2h	3h	5h
1.60V		1546	1156	930	771	625	378	270	167
1.65V		1457	1094	883	736	599	361	260	164
1.70V		1366	1030	836	699	572	345	247	161
1.75V		1276	967	787	661	543	330	236	157
1.80V		1187	903	738	623	514	304	217	149

(Note)The above characteristics data are average values obtained Within three charge/discharge cycles not the minimum values.