

NPG12-75Ah 12V75Ah

Specifications

Nominal Voltage		12V
Rated capacity (10 hour rate)		75Ah
Dimensions	Length	260±2mm(10.24inch)
	Width	168±2mm(6.61inch)
	Height	211±2mm(8.31inch)
	Total Height	215±2mm(8.46inch)
Approx. Weight		24.2kg(53.3lbs)±3%



Outer dimensions (mm)

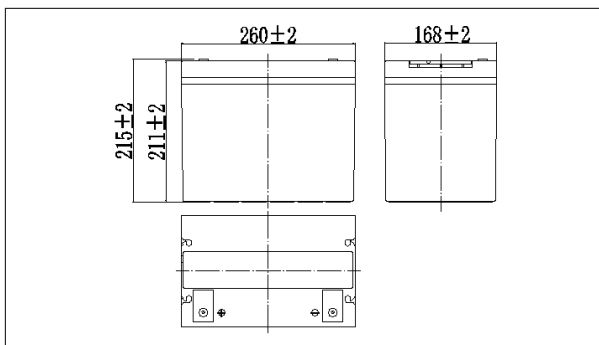

Terminal Type (mm)

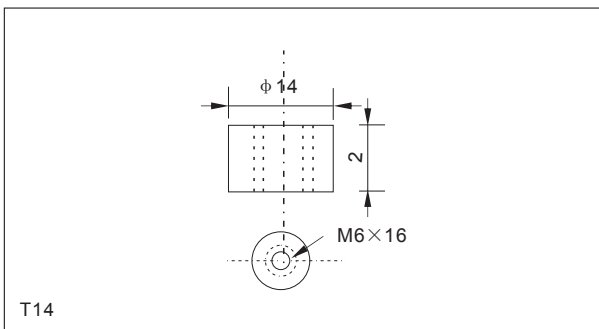

Characteristics

Capacity (25°C)	10HR(10.8V)	75Ah
	3HR(10.8V)	55.5Ah
	1HR(10.5V)	41Ah
Terminal type		T14
Internal resistance (Fully charged, 25°C)		Approx. 6mΩ
Capacity affected by temperature (10HR)	40°C	102%
	25°C	100%
	0°C	85%
	-15°C	65%
Self-discharge (25°C)	3 months	Remaining Capacity:91%
	6 months	Remaining Capacity:82%
	12 months	Remaining Capacity:65%
Nominal operating temperature		25°C ±3°C(77°F ±5°F)
Operating temperature range	Discharge	-15°C~50°C(5°F~122°F)
	Charge	-10°C~50°C(14°F~122°F)
	Storage	-20°C~50°C(-4°F~122°F)
Float charging voltage(25°C)		13.50 to 13.80V Temperature compensation: -18mV/°C
Cyclic charging voltage(25°C)		14.50 to 14.70V Temperature compensation: -30mV/°C
Maximum charging current		15A
Maximum discharge current		700A(5 sec.)
Designed floating life(20°C)		12years

Construction

Component	Positive plate	Negative plate	Container	Cover	Separator	Electrolyte	Safety valve	Terminal
Raw material	Lead dioxide	Lead	ABS	ABS	AGM	Gel	Rubber	Copper

Constant Current Discharge Characteristics Unit:A(25°C,77°F)

F.V/Time	10min	15min	30min	60min	2h	3h	4h	5h	8h	10h	20h
9.60V	146	120	72.8	45.0	27.4	19.5	15.3	13.0	9.18	7.64	4.05
9.90V	142	117	71.3	44.3	27.2	19.4	15.2	12.9	9.13	7.62	4.04
10.2V	136	113	69.1	43.2	27.0	19.3	15.1	12.8	9.06	7.60	4.03
10.5V	130	109	67.4	41.9	26.6	19.1	15.0	12.8	9.00	7.55	4.00
10.8V	123	103	65.0	40.5	25.9	18.7	14.6	12.4	8.73	7.50	3.98

Constant Power Discharge Characteristics Unit:W(25°C,77°F)

F.V/Time	10min	15min	30min	60min	2h	3h	4h	5h	8h	10h	20h
9.60V	1580	1318	816	513	317	229	180	154	109	91.2	48.6
9.90V	1532	1286	800	505	315	228	179	153	108	91.0	48.5
10.2V	1469	1239	775	492	313	226	178	152	108	90.7	48.3
10.5V	1406	1196	757	477	308	225	176	151	107	90.2	48.0
10.8V	1327	1133	729	462	300	220	171	146	104	89.6	47.7

Note: The above characteristics data can be obtained within three charge or discharge cycles.

NPG12-75Ah 12V75Ah

● **Discharge characteristics(25°C)**



● **Charging characteristics (25°C)**

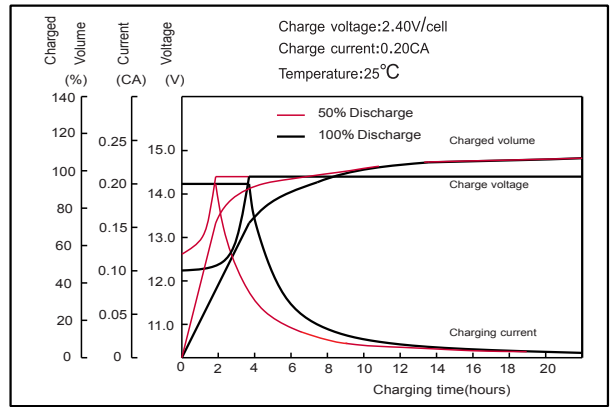

● **Temperature effects on Capacity**

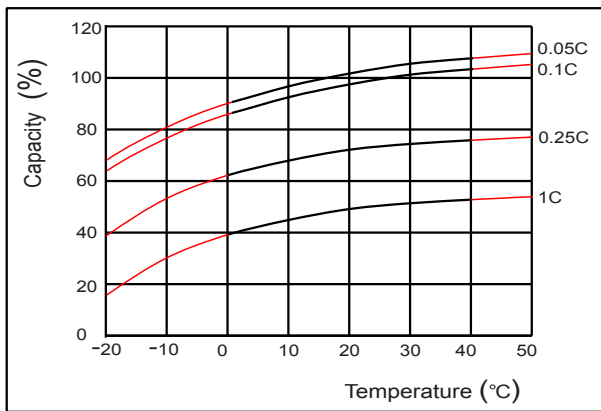

● **Self-discharge characteristics**



● **Floating life on Temperature**

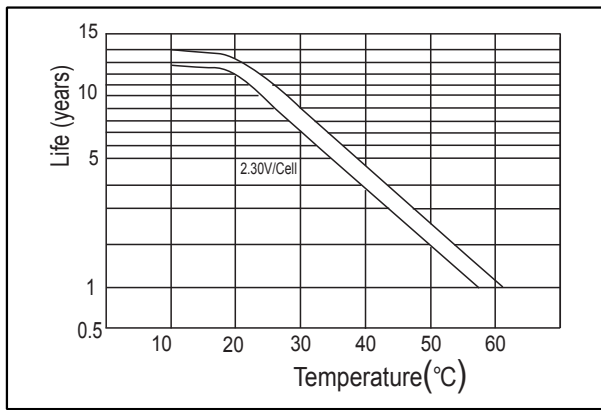

● **Cycle life on D.O.D (25°C)**

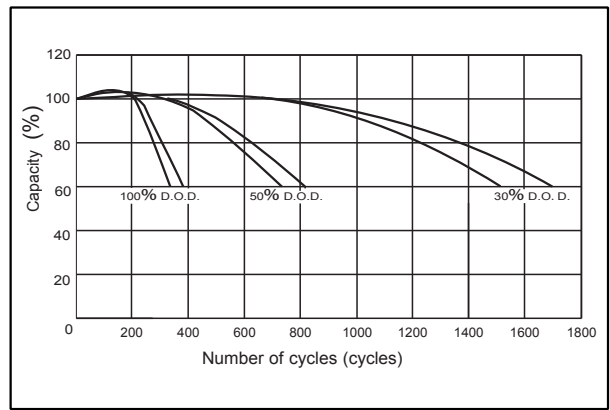

● **The relationship for OCV and Capacity (25°C)**

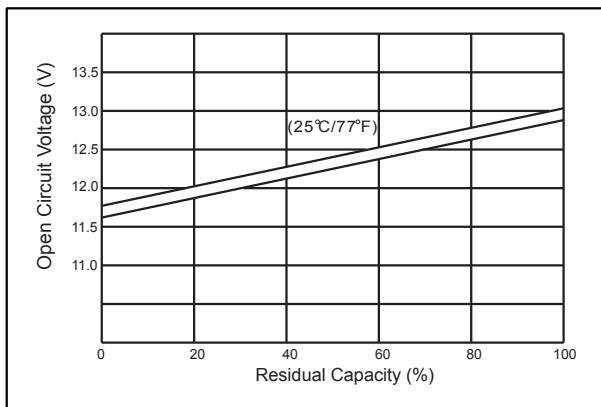

● **The relationship for Charging voltage and Temperature**

