





# MHJ Full Black series solar panels

autarco

Autarco's MHJ Full Black series solar panels use halfcut monocrystalline PERC cells with advanced multi-wire technology to deliver higher efficiency without compromising on reliability at a rated voltage of 1500V DC. The ability to withstand mechanical loads of up to 5400 Pa, combined with superior resistance to sand, salt and ammonia delivers long lasting performance in even the harshest environments.

- 
**25** Insured linear 25-year power output guarantee up to 84.8%  
12-year product warranty for materials and processing
- 
 Multiwire technology for superior reliability and performance
- 
 Halfcut PERC technology for reduced resistance loss and improved shade tolerance
- 
 PID resistant
- 
 Aesthetic cell colour consistency and hail resistant durability (45mm @ 30 m/s)

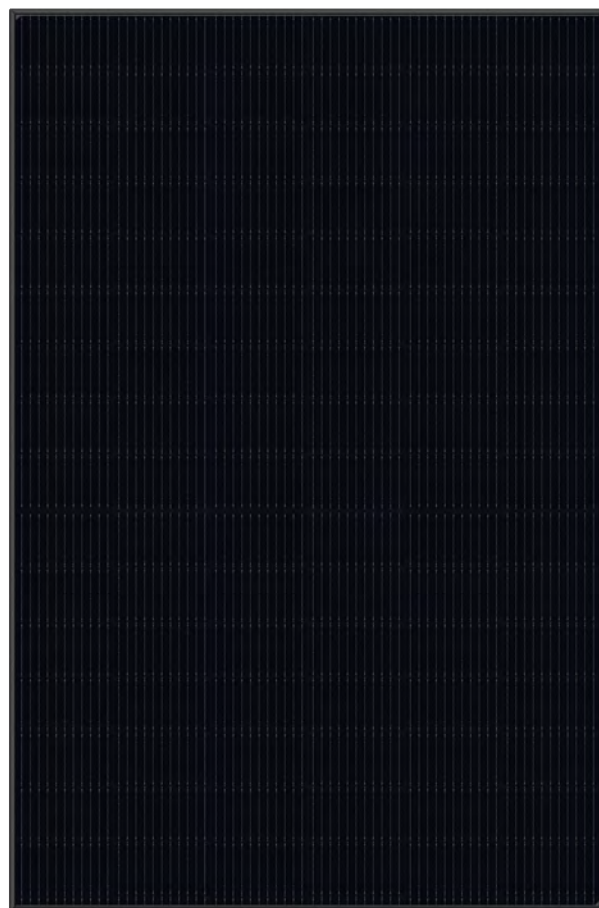

## QUALITY CERTIFICATES

- ◆ IEC 61215, IEC 61730, C US, CNAS, IEC/TS 62941
- ◆ ISO 9001, ISO 14001, OHSAS 18001, CE



## CELLS AND CONSTRUCTION

<b>Cells</b>	108 cells (182 x 91 mm) in a 2 x 6 x 9 matrix connected in series
<b>Junction box</b>	IP rating: IP68 Cable length: 1000mm Connector: PV Connector
<b>Diodes</b>	3 by-pass diodes
<b>Construction</b>	Front: 3.2mm glass (coated) Backsheet: PET/F-coating (black) Encapsulant: EVA
<b>Frame</b>	Anodized aluminum
<b>Weight</b>	21.3 kg
<b>Dimensions</b>	1722 x 1134 x 30mm

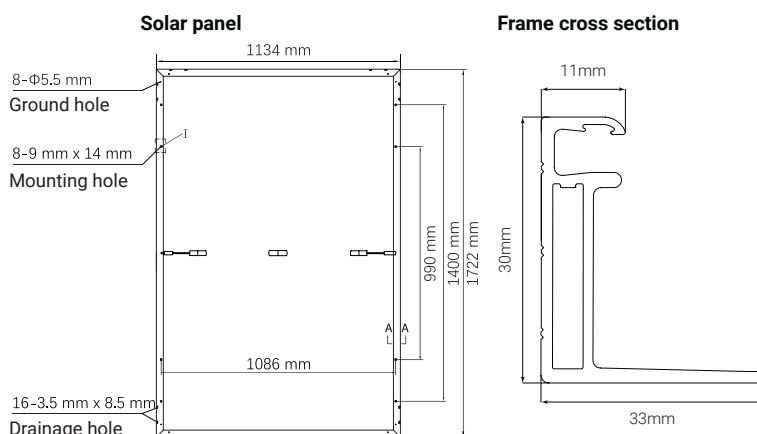

## IV CURVE

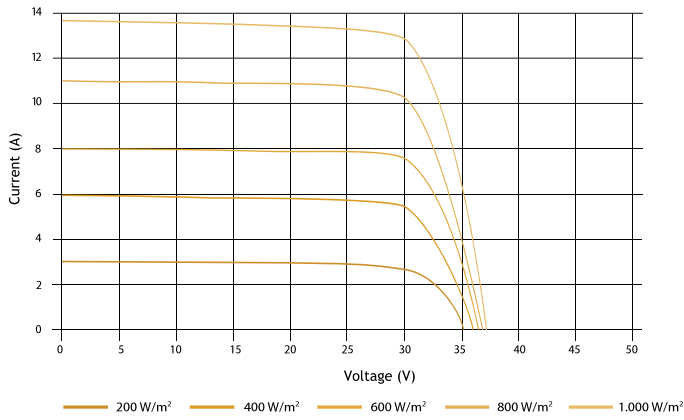

## POWER CURVE

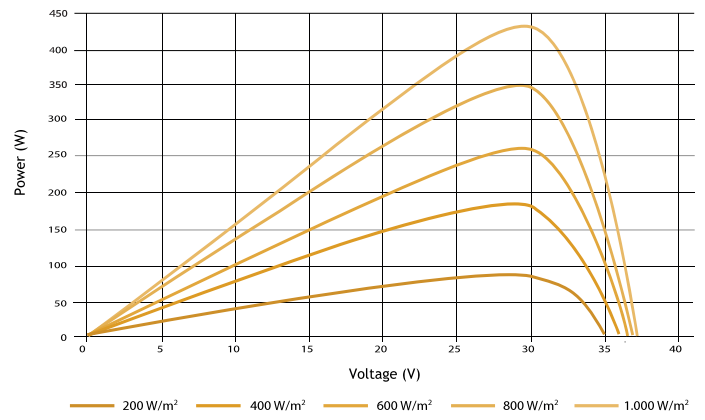

## ELECTRICAL CHARACTERISTICS

		S1.MHJ390B	S1.MHJ395B	S1.MHJ400B	S1.MHJ405B
Power output (Wp) *	(Pmax)	390	395	400	405
Power output tolerance (W)	(ΔPmax)	0/+5W	0/+5W	0/+5W	0/+5W
Open circuit voltage (V) at STC	(Voc)	36.60	36.80	37.00	37.20
Short circuit current (A) at STC	(Isc)	13.40	13.52	13.65	13.76
Max. power voltage (V) at STC	(Vmax)	30.76	30.92	31.09	31.26
Max. power current (A) at STC	(Imax)	12.68	12.77	12.86	12.96
Open circuit voltage (V) at NOCT	(Voc)	34.59	34.78	34.97	35.15
Short circuit current (A) at NOCT	(Isc)	10.87	10.97	11.07	11.17
Max. power voltage (V) at NOCT	(Vmax)	28.66	28.82	28.98	29.13
Max. power current (A) at NOCT	(Imax)	10.17	10.24	10.32	10.39
Module efficiency (%)	(η)	20.0	20.2	20.5	20.7
Maximum system voltage (V)		1500	1500	1500	1500
Maximum series fuse rating (A)		25	25	25	25

\* Electrical values at Standard Test Conditions (STC): irradiation 1000W/m<sup>2</sup>, air density AM1.5 and cell temperature 25°C

\* Electrical values at Nominal Operating Cell Temperature (NOCT): 800W/m<sup>2</sup>, air density AM1.5 and cell temperature 20°C, wind speed 1m/s

## TEMPERATURE CHARACTERISTICS

Isc (α)	+0.04% / °C
Voc (β)	-0.25% / °C
Pmax (γ)	-0.34% / °C
Nominal operating cell temperature	41°C (+/- 2°C)

## OTHER CHARACTERISTICS

Operating temperature	-40°C to 85°C
Max. load	5400 (front) / 2400 Pa (back)
Passed hail test	45mm hail @ 30.7m/s
Fire performance	Class C (IEC) or Type 2 (UL)
Weight of packaging	811 kg
Standard packaging	36 pcs / pallet
Quantity per 40'HQ container	936 pcs

The specifications contained in this datasheet may deviate slightly from our actual products due to on-going product improvement and are subject to change at any time without prior notice.

