



Solarlink New Energy Co., Ltd



Professional energy storage system manufacturer



Wall-mounted Low-Voltage Battery System



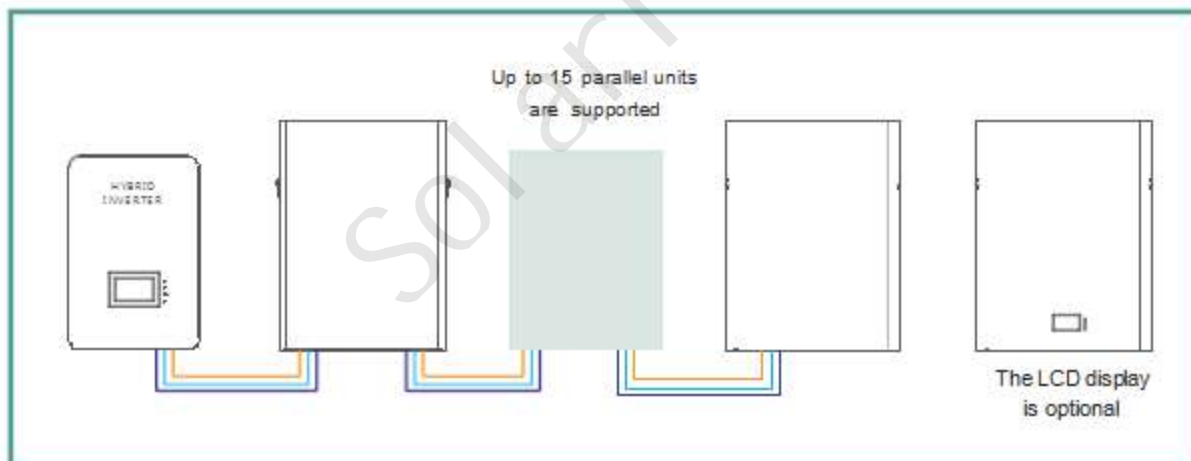
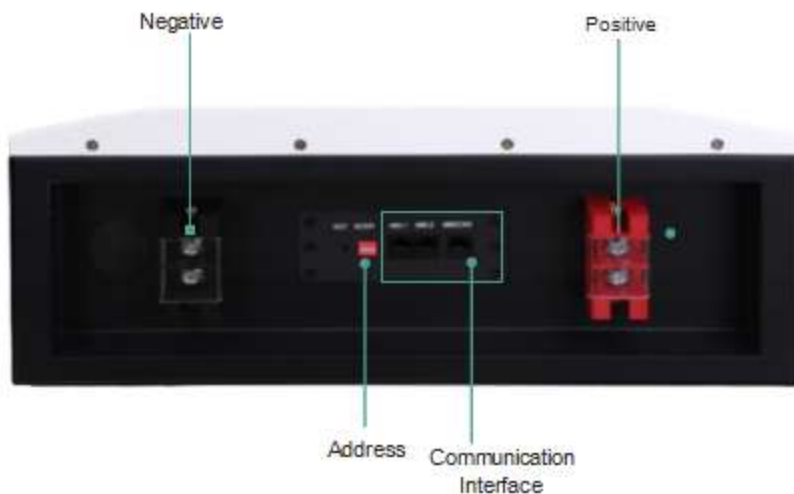

High performance LFP battery cells of major brands are selected, with cycle life of 4000 and service life of more than 10 years. The comprehensive operation cost is low.



Professional design and compact structure minimize the size, and the product is in harmony with the home environment.



With Perfect BMS protection function and all-round control system, the battery can run safely and efficiently.



CAN2.0, RS485 and RS232 communication protocols are supported, and inverters of various brands can be matched.



Product model	SI48100	SI51100	SI48200	SI51200
Product demo				
Battery cell parameters				
Battery cell type	LiFePO4	LiFePO4	LiFePO4	LiFePO4
Rated voltage	3.2V	3.2V	3.2V	3.2V
Rated capacity	16S1P	16S1P	16S1P	16S1P
Voltage range	2.8V-3.65V	2.8V-3.65V	2.8V-3.65V	2.8V-3.65V
Certification	UN38.3UL1973/IEC62619			
Product parameters				
Rated voltage	48V	51.2V	48V	51.2V
Series/Parallel	16S1P	16S1P	16S1P	16S1P
Working voltage range	37.5V-58.4V	40V-58.4V	37.5V-58.4V	40V-58.4V
Charge voltage	51V-51.75V	54.4V-55.2V	51V-51.75V	54.4V-55.2V
Floating charge voltage	50.25V-51V	53.6V-54.4V	50.25V-51V	53.6V-54.4V
Rated capacity	120Ah	120Ah	240Ah	240Ah
Energy	4.8KWH	5.12KWH	9.6KWH	10.24KWH
Rated charge current	100A/150A	100A/150A	100A/200A	100A/200A
Peak charge current	100A/150A	100A/150A	100A/200A	100A/200A
Rated discharge current	100A/150A	100A/150A	100A/200A	100A/200A
Peak discharge current	100A/150A	100A/150A	100A/200A	100A/200A
Product dimension(W*D*H)	650*475*190MM	650*475*190MM	920*800*150MM	1070*520*190MM
Product weight	67KG	69KG	120KG	120KG
Other parameters				
Charge temperature	0-55°C			
Discharge temperature	-10-55°C			
Optimum temperature	15-25°C			
Cooling method	Natural cooling			
IP rating	IP20			
Relative humidity	5%-95%			
Altitude	≤2000M			
Cycle life	≥4000 cycle@80%DOD, 0.5C/0.5C, 25°C			
Communication interfaces	CAN2.0/RS485/RS232			
Protection	Over temperature, over current, over voltage, insulation and other multiple protection, etc.			
Design lifetime	LCD( optional)			
Parallel Capability	≥10 years			
	Maximum 15 units (Recommended ≤5 units)			

# Lithium batteries instead of lead acid series

voltage	capacity	voltage range	maximum charging current	maximum discharge current	size/MM	weight/KG
12V	50Ah	10V-14.6V	25Ah	50Ah	230*138*208	6
12V	100Ah	10V-14.6V	50Ah/100Ah	100Ah	330*175*215	11.5
12V	150Ah	10V-14.6V	75Ah	100Ah	405*175*235	17
12V	200Ah	10V-14.6V	100Ah	100Ah/150Ah	485*170*240	21.5
12V	250Ah	10V-14.6V	100Ah/200Ah	100Ah/200Ah	525*240*220	28
12V	300Ah	20V-29.2V	100Ah/200Ah	100Ah/200Ah	525*240*220	29.5
12V	400Ah	20V-29.2V	100Ah/200Ah	100Ah/200Ah	525*240*220	38.5

支持WIFI  
SUPPORT WIFI

支持蓝牙  
SUPPORT BLUETOOTH

任意串并  
ARBITRARY SERIAL PARALLEL

升温功能  
TEMPERATURE RISE FUNCTION

空中升级  
AIR UPGRADE

# LiFePO4 Stacked low voltage battery system



Simple and convenient installation, such as 51.2V100Ah battery pack; Each system from 1 to 16 and from 5.12kWh to 81.92kWh! Users can easily plug in and enjoy the full power of energy storage products, and with a full set of well-cut, fit cables, all customers will be exquisite safe and reliable link design when installing this power system.



51.2V 100Ah 16 sets 81.92kWh parallel diagram



51.2V 100 ah



51.2V 300 ah



51.2V 600 ah



51.2V 800 ah



Select the industry brand high performance lithium iron phosphate cell, 4000 cycles, service life can reach more than 10 years, Low comprehensive operating cost.



Uniform battery box model design, no need to press fixed. The combination of battery boxes is arranged in sequence, with strong versatility.



Perfect BMS protection and control function, omnidirectional. Manage and protect the battery, so that the battery is always safe. Operate efficiently.



Support CAN2.0, RS485, RS232 communication protocols, Can meet a variety of different brands and styles of inverter. Use in combination.











Can be added touch LCD display, real-time view data and Running state, accurate control of all battery information.









Standard modular, truly realize wireless disassembly. Combination, convenient disassembly and assembly, simple and beautiful prod.

## 48V stacked battery pack

Product model	DC48100	DC48160	DC48200	DC48280
Product appearance				
				
<b>Battery pack unit</b>				
Unit voltage/capacity rating	48V 100Ah	48V 160Ah	48V 200Ah	48V 280Ah
Types of batteries,	LiFePO4	LiFePO4	LiFePO4	LiFePO4
Battery box configuration	15S1P	15S1P	15S1P	15S1P
Battery Case size	630*423*198mm	681*423*230mm	681*425*277mm	776*425*282mm
Battery box weight	47.3 KG	67.1 KG	89.8 G	118.1 KG
Maximum number of	16P	16P	16P	16P
<b>16 sets of parallel system parameters</b>				
The rated voltage	48V	48V	48V	48V
Operating voltage range	37.5V to 54.75 V	37.5V to 54.75 V	37.5V to 54.75 V	37.5V to 54.75 V
Charging voltage range	37.5V to 54.75 V	37.5V to 54.75 V	37.5V to 54.75 V	37.5V to 54.75 V
System to code mode	Automatically to code	Automatically to code	Automatically to code	Automatically to code
Nominal capacity	1600 Ah	2560 Ah	3200 Ah	4480 Ah
The rated power	76.8 kWh	122.9 kWh	153.6 kWh	215 kWh
Recommend Charging current	320 A	512 A	640 A	896 A
Maximum charging current	1600 A	1600 A	2400 A	2400 A
Rated discharge current	1600 A	1600 A	2400 A	2400 A
Maximum discharge current	1600 A	1600 A	2400 A	2400 A
Product size	896*630*1572 mm	900*681*1828 mm	900*681*2204 mm	900*776*2244 mm
The product weight	762 kg	1080 kg	1445 kg	1897 kg
<b>The other parameters</b>				
Charging temperature range	0 to 60 °C			
Discharge temperature range	-20 to 60 °C			
operating temperature	15 to 27 °C			
Cooling way	Natural cooling			
Working relative humidity	5% - 95%.			
Cycle life	≥4000 times @80%DOD, 0.5C/0.5C, 25°C			
Communication methods	CAN2.0 / RS485 / RS232			
Protection function	Over temperature, over current, short circuit, over charge, over discharge, etc			
Type of display	LCD touch screen, SOC indicator, etc. to be selected on demand			
Design service life	10 years or more			
certification	UN38.3 / MSDS/UL1973 / IEC62619 / ROHS/CE			
Other requirements	OEM,ODM,OBM,CMT			

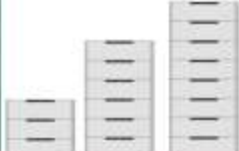

## 51.2V stacked battery pack

Product	DC512100	DC512160	DC512200	DC512280
Product				
				
<b>Battery pack unit</b>				
Unit voltage/capacity rating	51.2 V 100 ah	51.2 V 160 ah	51.2 V 200 ah	51.2 V 280 ah
Types of batteries,	LiFePO4	LiFePO4	LiFePO4	LiFePO4
Battery box configuration	16S1P	16S1P	16S1P	16S1P
Battery Case size	630*423*198mm	681*423*230mm	681*425*277mm	776*425*282mm
Battery box weight	49.5 KG	70.5 KG	93.5 KG	123.8 KG
Maximum parallel	16P	16P	16P	16P
<b>16 sets of parallel system parameters</b>				
The rated voltage	51.2 V	51.2 V	51.2 V	51.2 V
Operating voltage range	40 V to 58.4 V	40 V to 58.4 V	40 V to 58.4 V	40 V to 58.4 V
Charging voltage range	40 V to 58.4 V	40 V to 58.4 V	40 V to 58.4 V	40 V to 58.4 V
System code mode	Automatically to code	Automatically to code	Automatically to code	Automatically to code
Nominal capacity	1600 Ah	2560 Ah	3200 Ah	4480 Ah
The rated power	81.9 kWh	131.1 kWh	163.8 kWh	229.4 kWh
Recommend charging current	320 A	512 A	640 A	896 A
Maximum charging current	1600 A	1600 A	2400 A	2400 A
Rated discharge current	1600 A	1600 A	2400 A	2400 A
Maximum discharge current	1600 A	1600 A	2400 A	2400 A
Product size	896*630*1572 mm	900*681*1828 mm	900*681*2204 mm	900*776*2244 mm
The product weight	796 kg	1131 kg	1511 kg	1987 kg
<b>The other parameters</b>				
Charging temperature range	0 to 60 °C			
Discharge temperature range	- 20 to 60 °C			
operating temperature	15 to 27 °C			
Cooling way	Natural cooling			
Working relative humidity	5% - 95%.			
Cycle life	≥4000 times @80%DOD, 0.5C/0.5C, 25°C			
Communication methods	CAN2.0 / RS485 / RS232			
Protection function	Over temperature, over current, short circuit, over charge, over discharge, etc			
Type of display	LCD touch screen, SOC indicator, etc. to be selected on demand			
Design service life	10 years or more			
certification	UN38.3 / MSDS/UL1973 / IEC62619 / ROHS/CE			
Other requirements	OEM,ODM,OBM,CMT			





## *Rack-mounted Low-Voltage Battery System*



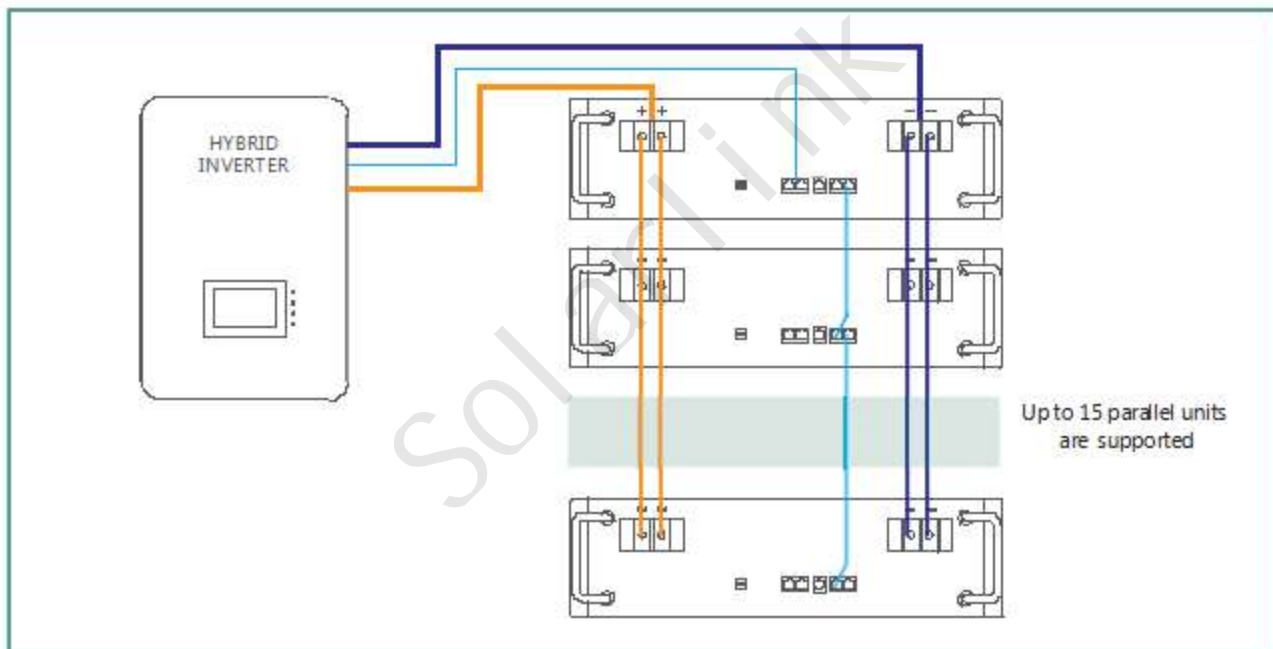
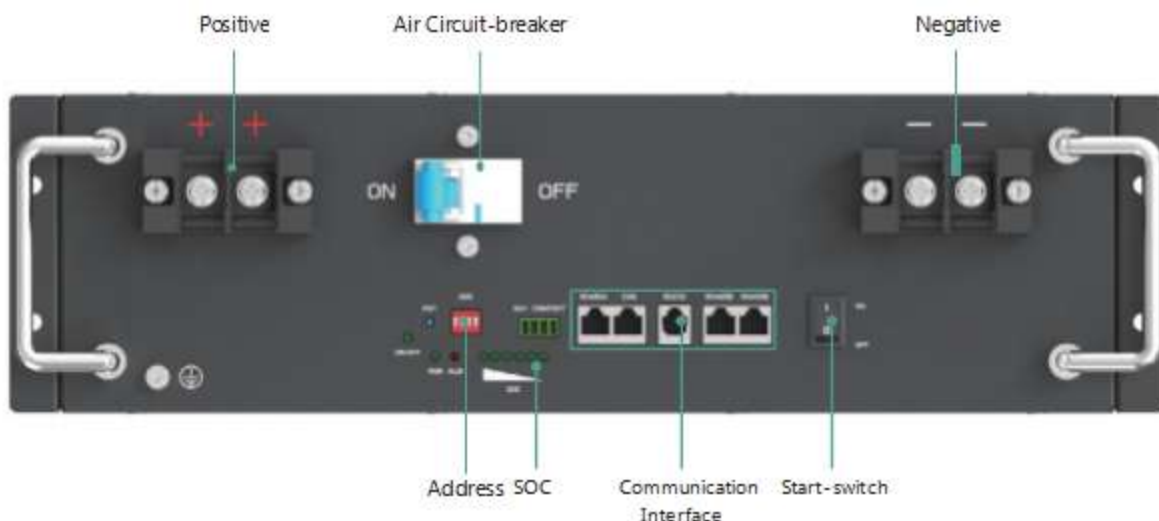

High performance LFP battery cells of major brands are selected, with cycle life of 4000 and service life of more than 10 years. The comprehensive operation cost is low.



Standard chassis design makes the assembly convenient and fast. Combined products can meet the needs of different capacity and power.







With Perfect BMS protection function and all-round control system, the battery can run safely and efficiently.



CAN2.0, RS485 and RS232 communication protocols are supported, and inverters of various brands can be matched.



Product model	KJ048100	KD051100	KJ048200	KJ051200
Product demo				
Battery cell type	LiFePO4	LiFePO4	LiFePO4	LiFePO4
Rated voltage	3.2V	3.2V	3.2V	3.2V
Rated capacity	15S1P	16S1P	16S1P	16S1P
Voltage range	2.8V-3.65V	2.8V-3.65V	2.8V-3.65V	2.8V-3.65V
Certification	UN38.3/UL1973/IEC62619			
Rated voltage	48V	51.2V	48V	51.2V
Serial/Parallel	15S1P	16S1P	15S1P	16S1P
Working voltage range	37.5V-58.4V	40V-58.4V	37.5V-58.4V	40V-58.4V
Charge voltage	51V-51.75V	54.4V-55.2V	51V-51.75V	54.4V-55.2V
Floating charge voltage	50.25V-51V	53.6V-54.4V	50.25V-51V	53.6V-54.4V
Rated capacity	100Ah	100Ah	200Ah	200Ah
Energy	4.8KWH	5.12KWH	9.6KWH	10.24KWH
Rated charge current	100A	100A	100A	100A
Peak charge current	100A	100A	100A	100A
Rated discharge current	100A	100A	100A	100A
Peak discharge current	100A	100A	100A	100A
Product dimension(W*D*H)	482.6*540*132.5MM	482.6*540*132.5MM	482.6*570*221.5MM	482.6*570*221.5MM
Product weight	35.5KG	37.5KG	73.5KG	78KG
Charge temperature	0-55°C			
Discharge temperature	-10-55°C			
Optimum temperature	15-25°C			
Cooling method	Natural cooling			
IP rating	IP20			
Relative humidity	5%-95%			
Altitude	≤2000M			
Cycle life	≥4000 cycles@80%DOD , 0.5C/0.5C , 25°C			
Communication interfaces	CAN2.0/RS485/RS232			
Protection	Over temperature, over current, over voltage, insulation and other multiple protection , etc .			
Design lifetime	≥10years			
Parallel Capability	Maximum 15 units (Recommended ≤5 units)			





Committed to providing  
safe, stable, cost - effective green energy products

## ***High-Voltage Energy Storage***

## 204.8V Series High-Voltage Energy Storage



Modular design, standardized production, strong commonality, easy installation, operation and maintenance.



Perfect BMS protection function and control system, over current, over voltage, insulation and other multiple protection design.



Using lithium iron phosphate cell, low internal resistance, high rate, high safety, long life. High consistency of internal resistance, voltage and capacity of single cell.



The cycle times can reach more than 3500 times, the service life is more than 10 years, the comprehensive operation cost is low.



Intelligent system, low loss, high conversion efficiency, strong stability, reliable operation.





Visual LCD display allows you to set operating parameters, view real-time data and operating status, and accurately diagnose operating faults.



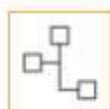

Support fast charging and discharging.



Supports communication protocol such as CAN2.0 and RS485, which can be used in various scenarios.

Product model	204050	204080	204105
System demo			
<b>Battery module</b>			
Module mode	51.2V50Ah	51.2V80Ah	51.2V105Ah
Serial/ Parallel	16S1P	16S1P	16S1P
Module dimension	4826*416.2*132.5MM	4826*416.2*177MM	482.6*416.2*177MM
Module weight	30KG	41.5KG	46.5KG
Number of modules	4PCS	4PCS	4PCS
Battery type	LiFePO4	LiFePO4	LiFePO4
<b>System parameters</b>			
Rated voltage	2048V		
Working voltage range	147.2-233.6V		
Charge voltage	217.6-220.8V		
Floating charge voltage	214.4-217.6V		
Rated capacity	50Ah	80Ah	105Ah
Energy	10.24KWh	16.37KWh	21.5KWh
Rated charge current	25A	40A	50A
Peak charge current	50A	80A	105A
Rated discharge current	50A	80A	105A
Peak discharge current	100A	160A	210A
Charge temperature	0-55℃		
Discharge temperature	-10-55℃		
Optimum temperature	15-25℃		
Cooling method	Natural cooling		
Relative humidity	5%-95%		
Altitude	≤2000M		
Cycle Life	≥3500次@80%DOD, 0.5C/0.5C, 25℃		
Communication interfaces	CAN2.0/RS485/Dry		
Protection	Over temperature, over current, over voltage, insulation and other multiple protection		
Display	LCD		
Design lifetime	≥10 years		
Certification	UN38.3/UL1973/IEC62619		
Dimension( L* W* H)	600*600*1109MM	600*600*1287MM	600*600*1287MM
Weight	205KG	255KG	275KG

Product model	204160	204230	204280
System demo			
<b>Battery module</b>			
Module mode	51.2V160Ah	51.2V230Ah	51.2V280Ah
Serial/ Parallel	16S2P	16S1P	16S1P
Module dimension	482.6*554*221.5MM	482.6*614*265.9MM	482.6*754*265.9MM
Module weight	72KG	90KG	114KG
Number of modules	4PCS	4PCS	4PCS
Battery type	LiFePO4	LiFePO4	LiFePO4
<b>System parameters</b>			
Rated voltage	204.8V		
Working voltage range	147.2-233.6V		
Charge voltage	217.6-220.8V		
Floating charge voltage	214.4-217.6V		
Rated capacity	160Ah	230Ah	280Ah
Energy	32.76KWh	47.1KWh	57.34KWh
Rated charge current	80A	115A	140A
Peak charge current	160A	230A	280A
Rated discharge current	160A	230A	280A
Peak discharge current	320A	460A	460A
Charge temperature	0-55℃		
Discharge temperature	-10-55℃		
Optimum temperature	15-25℃		
Cooling method	Natural cooling		
Relative humidity	5%-95%		
Altitude	≤2000M		
Cycle Life	≥3500次@80%DOD, 0.5C/0.5C, 25℃		
Communication interfaces	CAN2.0/RS485/Dry		
Protection	Over temperature, over current, over voltage, insulation and other multiple protection		
Display	LCD		
Design lifetime	≥10 years		
Certification	UN38.3/UL1973/IEC62619		
Dimension( L* W* H)	600*600*1465MM	600*660*1643MM	600*800*1643MM
Weight	385KG	465KG	565KG

## 256V Series High-Voltage Energy Storage



Modular design, standardized production, strong commonality, easy installation, operation and maintenance.



Perfect BMS protection function and control system, over current, over voltage, insulation and other multiple protection design.



Using lithium iron phosphate cell, low internal resistance, high rate, high safety, long life. High consistency of internal resistance, voltage and capacity of single cell.



The cycle times can reach more than 3500 times, the service life is more than 10 years, the comprehensive operation cost is low.



Intelligent system, low loss, high conversion efficiency, strong stability, reliable operation.



LCD

Visual LCD display allows you to set operating parameters, view real-time data and operating status, and accurately diagnose operating faults.





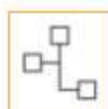



Support fast charging and discharging.



Supports communication protocol such as CAN2.0 and RS485, which can be used in various scenarios.



Product model	256050	256080	256105
System demo			
<b>Battery module</b>			
Module mode	51.2V50Ah	51.2V80Ah	51.2V105Ah
Serial/ Parallel	16S1P	16S1P	16S1P
Module dimension	4826*416.2*132.5MM	4826*416.2*177MM	482.6*416.2*177MM
Module weight	30KG	41.5KG	46.5KG
Number of modules	5PCS	5PCS	5PCS
Battery type	LiFePO4	LiFePO4	LiFePO4
<b>System parameters</b>			
Rated voltage	256V		
Working voltage range	184-292V		
Charge voltage	272-276V		
Floating charge voltage	268-272V		
Rated capacity	50Ah	80Ah	105Ah
Energy	12.8KWh	20.48KWh	26.88KWh
Rated charge current	25A	40A	50A
Peak charge current	50A	80A	105A
Rated discharge current	50A	80A	105A
Peak discharge current	100A	160A	210A
Charge temperature	0-55℃		
Discharge temperature	-10-55℃		
Optimum temperature	15-25℃		
Cooling method	Natural cooling		
Relative humidity	5%-95%		
Altitude	≤2000M		
Cycle Life	≥3500次@80%DOD, 0.5C/0.5C, 25℃		
Communication interfaces	CAN2.0/RS485/Dry		
Protection	Over temperature, over current, over voltage, insulation and other multiple protection		
Display	LCD		
Design lifetime	≥10 years		
Certification	UN38.3/UL1973/IEC62619		
Dimension(L* W* H)	600*600*1287MM	600*600*1510MM	600*600*1510MM
Weight	240KG	300KG	325KG

Product model	256160	256230	256280
System demo			
<b>Battery module</b>			
Module mode	51.2V160Ah	51.2V230Ah	51.2V280Ah
Serial/ Parallel	16S2P	16S1P	16S1P
Module dimension	482.6*554*221.5MM	482.6*614*265.9MM	482.6*754*265.9MM
Module weight	72KG	90KG	114KG
Number of modules	5PCS	5PCS	5PCS
Battery type	LiFePO4	LiFePO4	LiFePO4
<b>System parameters</b>			
Rated voltage	256V		
Working voltage range	184-292V		
Charge voltage	272-276V		
Floating charge voltage	268-272V		
Rated capacity	160Ah	230Ah	280Ah
Energy	40.96KWh	59.34KWh	71.68KWh
Rated charge current	80A	115A	140A
Peak charge current	160A	230A	280A
Rated discharge current	160A	230A	280A
Peak discharge current	320A	460A	460A
Charge temperature	0-55℃		
Discharge temperature	-10-55℃		
Optimum temperature	15-25℃		
Cooling method	Natural cooling		
Relative humidity	5%-95%		
Altitude	≤2000M		
Cycle Life	≥3500次@80%DOD, 0.5C/0.5C, 25℃		
Communication interfaces	CAN2.0/RS485/Dry		
Protection	Over temperature, over current, over voltage, insulation and other multiple protection		
Display	LCD		
Design lifetime	≥10 years		
Certification	UN38.3/UL1973/IEC62619		
Dimension( L* W* H)	600*600*1732MM	600*660*1954MM	600*800*1954MM
Weight	463KG	564KG	696KG

## 409. 6V Series High-Voltage Energy Storage



Modular design, standardized production, strong commonality, easy installation, operation and maintenance.



Perfect BMS protection function and control system, over current, over voltage, insulation and other multiple protection design.



Using lithium iron phosphate cell, low internal resistance, high rate, high safety, long life. High consistency of internal resistance, voltage and capacity of single cell.



The cycle times can reach more than 3500 times, the service life is more than 10 years, the comprehensive operation cost is low.



Intelligent system, low loss, high conversion efficiency, strong stability, reliable operation.





Visual LCD display allows you to set operating parameters, view real-time data and operating status, and accurately diagnose operating faults.

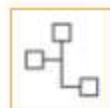

Support fast charging and discharging.

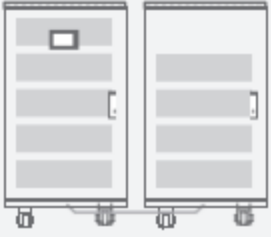

Supports communication protocol such as CAN2.0 and RS485, which can be used in various scenarios.

Product model	409050	409080	409105
System demo			
<b>Battery module</b>			
Module mode	51.2V50Ah	51.2V80Ah	51.2V105Ah
Serial/ Parallel	16S1P	16S1P	16S1P
Module dimension	4826*416.2*132.5MM	4826*416.2*177MM	482.6*416.2*177MM
Module weight	30KG	41.5KG	46.5KG
Number of modules	8PCS	8PCS	8PCS
Battery type	LiFePO4	LiFePO4	LiFePO4
<b>System parameters</b>			
Rated voltage		409.6V	
Working voltage range		294.4-467.2V	
Charge voltage		435.2-441.6V	
Floating charge voltage		428.8-435.2V	
Rated capacity	50Ah	80Ah	105Ah
Energy	19.2KWh	30.72KWh	40.32KWh
Rated charge current	25A	40A	50A
Peak charge current	50A	80A	105A
Rated discharge current	50A	80A	105A
Peak discharge current	100A	160A	210A
Charge temperature		0-55℃	
Discharge temperature		-10-55℃	
Optimum temperature		15-25℃	
Cooling method		Natural cooling	
Relative humidity		5%-95%	
Altitude		≤2000M	
Cycle Life		≥3500次@80%DOD, 0.5C/0.5C, 25℃	
Communication interfaces		CAN2.0/RS485/Dry	
Protection	Over temperature, over current, over voltage, insulation and other multiple protection		
Display	LCD		
Design lifetime		≥10 years	
Certification	UN38.3/UL1973/IEC62619		
Dimension(L* W* H)	(600*600*1109MM)*2	(600*600*1287MM)*2	(600*600*1287MM)*2
Weight	204.5KG+189.5KG	253.5KG+238.5KG	275KG+260KG

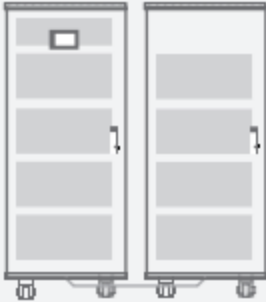
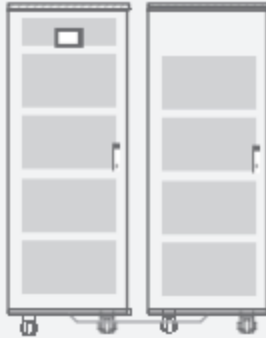
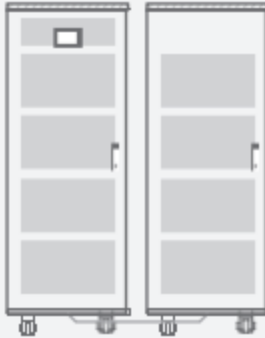
Product model	409160	409230	409280
System demo			
<b>Battery module</b>			
Module mode	51.2V160Ah	51.2V230Ah	51.2V280Ah
Serial/ Parallel	16S2P	16S1P	16S1P
Module dimension	482.6*554*221.5MM	482.6*614*265.9MM	482.6*754*265.9MM
Module weight	72KG	90KG	114KG
Number of modules	8PCS	8PCS	8PCS
Battery type	LiFePO4	LiFePO4	LiFePO4
<b>System parameters</b>			
Rated voltage	409.6V		
Working voltage range	294.4-467.2V		
Charge voltage	435.2-441.6V		
Floating charge voltage	428.8-435.2V		
Rated capacity	160Ah	230Ah	280Ah
Energy	61.44KWh	88.32KWh	107.52KWh
Rated charge current	80A	115A	140A
Peak charge current	160A	230A	280A
Rated discharge current	160A	230A	280A
Peak discharge current	320A	460A	460A
Charge temperature	0-55℃		
Discharge temperature	-10-55℃		
Optimum temperature	15-25℃		
Cooling method	Natural cooling		
Relative humidity	5%-95%		
Altitude	≤2000M		
Cycle Life	≥3500次@80%DOD, 0.5C/0.5C, 25℃		
Communication interfaces	CAN2.0/RS485/Dry		
Protection	Over temperature, over current, over voltage, insulation and other multiple protection		
Display	LCD		
Design lifetime	≥10 years		
Certification	UN38.3/UL1973/IEC62619		
Dimension( L* W* H)	(600*600*1465MM)*2	600*660*1643MM	600*800*1643MM
Weight	386.5KG+371.5KG	464KG+449KG	562.5KG+547.5KG

# 512V Series High-Voltage Energy Storage



Modular design, standardized production, strong commonality, easy installation, operation and maintenance.



Perfect BMS protection function and control system, over current, over voltage, insulation and other multiple protection design.



Using lithium iron phosphate cell, low internal resistance, high rate, high safety, long life. High consistency of internal resistance, voltage and capacity of single cell.



The cycle times can reach more than 3500 times, the service life is more than 10 years, the comprehensive operation cost is low.



Intelligent system, low loss, high conversion efficiency, strong stability, reliable operation.





Visual LCD display allows you to set operating parameters, view real-time data and operating status, and accurately diagnose operating faults.

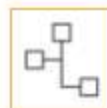

Support fast charging and discharging.



Supports communication protocol such as CAN2.0 and RS485, which can be used in various scenarios.

Product model	512050	512080	512105
System demo			
<b>Battery module</b>			
Module mode	51.2V50Ah	51.2V80Ah	51.2V105Ah
Serial/ Parallel	16S1P	16S1P	16S1P
Module dimension	4826*416.2*132.5MM	4826*416.2*177MM	482.6*416.2*177MM
Module weight	30KG	41.5KG	46.5KG
Number of modules	10PCS	10PCS	10PCS
Battery type	LiFePO4	LiFePO4	LiFePO4
<b>System parameters</b>			
Rated voltage	512V		
Working voltage range	368-584V		
Charge voltage	544-552V		
Floating charge voltage	536-544V		
Rated capacity	50Ah	80Ah	105Ah
Energy	25.6KWh	40.96KWh	53.76KWh
Rated charge current	25A	40A	50A
Peak charge current	50A	80A	105A
Rated discharge current	50A	80A	105A
Peak discharge current	100A	160A	210A
Charge temperature	0-55℃		
Discharge temperature	-10-55℃		
Optimum temperature	15-25℃		
Cooling method	Natural cooling		
Relative humidity	5%-95%		
Altitude	≤2000M		
Cycle Life	≥3500次@80%DOD, 0.5C/0.5C, 25℃		
Communication interfaces	CAN2.0/RS485/Dry		
Protection	Over temperature, over current, over voltage, insulation and other multiple protection		
Display	LCD		
Design lifetime	≥10 years		
Certification	UN38.3/UL1973/IEC62619		
Dimension( L* W* H)	(600*600*1287MM)*2	(600*600*1510MM)*2	(600*600*1510MM)*2
Weight	240KG+225KG	300KG+285KG	325KG+310KG

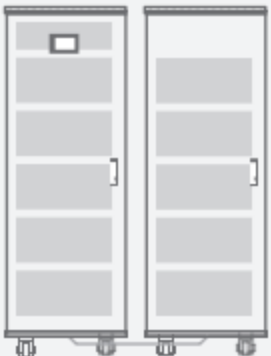
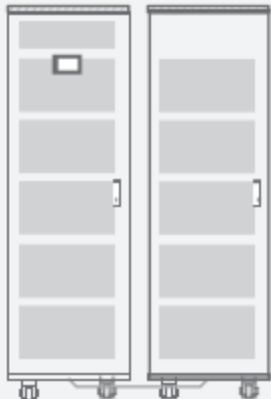
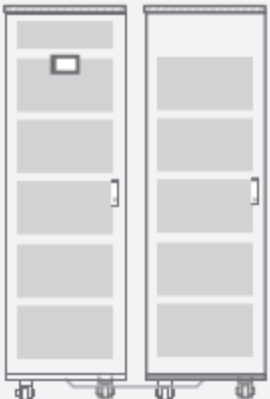
Product model	512160	512230	512280
System demo			
<b>Battery module</b>			
Module mode	512V160Ah	51.2V230Ah	51.2V280Ah
Serial/ Parallel	16S2P	16S1P	16S1P
Module dimension	482.6*554*221.5MM	482.6*614*265.9MM	482.6*754*265.9MM
Module weight	72KG	90KG	114KG
Number of modules	10PCS	10PCS	10PCS
Battery type	LiFePO4	LiFePO4	LiFePO4
<b>System parameters</b>			
Rated voltage	512V		
Working voltage range	368-584V		
Charge voltage	544-552V		
Floating charge voltage	536-544V		
Rated capacity	160Ah	230Ah	280Ah
Energy	81.92KWh	117.76KWh	143.36KWh
Rated charge current	80A	115A	140A
Peak charge current	160A	230A	280A
Rated discharge current	160A	230A	280A
Peak discharge current	320A	460A	460A
Charge temperature	0-55℃		
Discharge temperature	-10-55℃		
Optimum temperature	15-25℃		
Cooling method	Natural cooling		
Relative humidity	5%-95%		
Altitude	≤2000M		
Cycle Life	≥3500次@80%DOD, 0.5C/0.5C, 25℃		
Communication interfaces	CAN2.0/RS485/Dry		
Protection	Over temperature, over current, over voltage, insulation and other multiple protection		
Display	LCD		
Design lifetime	≥10 years		
Certification	UNB8.3/UL1973/IEC62619		
Dimension( L* W* H)	(600*600*1732MM)*2	(600*660*1954MM)*2	(600*800*1954MM)*2
Weight	463KG+448KG	564KG+549KG	696KG+681KG