

Shenzhen TAICO Technology Co., Ltd

500 Kw~806.4Kwh Solar Storage System



Project : 806.4kWh Energy Storage

Location : Tibet, China

Scale : 500kW/806.4kWh

Date : April, 2021.

Table of contents

1 Introduction	- 3 -
1.1 Project	
Background	- 3 -
1.2 Terminology	- 3 -
-	
1.3 Reference	
Standard	- 4
-	
2 System	
Design	
- 6 -	
2.1 Power storage converter (PCS) selection	
design	- 7 -
2.1.1 Functional introduction of energy storage	
converter	- 7 -
2.1.2 500kW Selection and design of energy storage	
converters	- 8 -
2.1.3 Energy storage converter protection strategy	- 10 -
2.1.4 500kW Dimensional installation design of energy storage	
converter	- 12 -
2.2 Energy Management System (EMS)	
Design	- 13 -
2.2.1 EMS Introduction to system functions	- 13 -
2.2.2 EMS Network Architecture	- 13 -
-	
2.2.3 EMS Functional Design	- 14 -
2.2.4 EMS Technical parameter table	- 16 -
2.3 Container Layout Design	- 16 -
2.4 System heat dissipation scheme	- 17
-	
2.5 Fire protection system scheme	- 17 -
2.5.1 Working principle of cabinet type heptafluoropropane fire extinguisher	
system	- 17 -
2.5.2 Introduction to the main functions and components of each part of the	
system	- 18 -
2.5.3 The technical parameters of each main	
equipment	- 19 -
2.6 Access control system and lighting solution	- 22 -
- 22 -	
2.7 Lithium battery	
introduction	- 22 -
2.7.1 The main parameters of the battery	- 22 -
2.7.2 battery pack and clustering	- 24 -
2.8 Battery Management System	
(BMS)	- 25 -
2.8.1 Topology diagram	- 25 -
2.8.2 BMS Function Description	- 26 -
2.8.3 BMS The composition and function description of the battery management	
system	- 27 -
3 System	
installation	- 30 -
3.1 Preparations for	
installation	- 30 -

- 3.1.1 Check before installation - 30 -
- 3.1.2 Installation tools and parts - 31 -
- 3.2 mechanical
installation - 31 -
- 3.2.1 Mechanical Installation
Requirements - 31 -
- 3.3 Electrical
Installation - 35 -
- 3.3.1 Grounding system connection - 35 -
- 3.3.2 AC cable connection - 36 -
- 3.3.3 Communication cable connection - 36 -
- 4Equipment
list - 37-

1 Introduction

This document is prepared according to the relevant technical standards of energy storage power stations. Including the general description of the product, hardware environment, specific functional requirements and other related support information, relevant development tasks and relevant developer s to carry out specific work based on this .

1.1 Project Background

The project is a project planning and construction project. By installing the energy storage system in the container for self-storage and self-use, and cooperating with new energy power generation, the purpose of saving electricity expenses is achieved. At the same time, The energy storage system can be used for demand response, emergency power supply, etc.

1.2 Terminology

1>PCS (PowerCovertSystem) : The energy storage converter is a bidirectional converter device for inversion and rectification.

2>SOC (State Of Capacity) : Status of remaining battery capacity, expressed as a percentage.

3>SOH (State Of Health) : Battery pack health status, expressed as a percentage.

4>DOD (Depth Of Discharge) : The depth of discharge of the battery, expressed as a percentage.

5>BMS (Battery ManagementSystem) : The battery management system is responsible for the management and control of the battery part of the energy storage system.

6>EMS (Energy Management System): The energy management system is responsible for the management and control of the energy storage system, including energy storage converters, battery systems, air conditioning systems, and fire protection systems.

1.3 Reference Standards

- 1>GB/T3859.1-1993 Basic requirements for semiconductor converters
- 2>GB/T3859.2-2013 General requirements for semiconductor converters and grid-commutated converters Part 1-2: Application guidelines
- 3>GB/T13422-2013 Electrical test methods for semiconductor power converters
- 4>GB/T2423.1-2001 Environmental Test of Electrical and Electronic Products Part 2: Test Method Test A: Low temperature
- 5>GB/T2423.2-2001 Environmental Testing of Electrical and Electronic Products Part 2: Test Method Test B: High Temperature
- 6>GB/T2423.3-2006 Environmental Test of Electrical and Electronic Products Part 2: Test Method Test Cab: Constant Damp Heat Test
- 7>GB/T2423.4-2008 Environmental Testing of Electrical and Electronic Products Part 2: Test Method Test Db Alternating Damp Heat (12h+12h Cycle)
- 8>GB/T12325-2008 Power Quality Supply Voltage Deviation
- 9>GB/T12326-2008 Power Quality Voltage Fluctuation and Flicker
- 10>GB/T14549-1993 Power Quality Harmonics of Public Grid
- 11>GB/T15543-2008 Three-phase voltage unbalance of power quality
- 12>GB/T15945-2008 Frequency deviation of power quality power system
- 13>GB/Z17625.3-2000 Electromagnetic Compatibility Limits Limitation of Voltage Fluctuation and Flicker in Low-Voltage Power Supply Systems for Equipment with a Rated Current of More than 16A
- 14>DL/T860 (all) telecontrol equipment and systems (series standards)
- 15>DL/T634 (all) telecontrol equipment and systems (series standards)
- 16>DL/T645-1997 Multifunctional Electric Energy Meter Communication Protocol
- 17>DL5002-2005 Technical Regulations for Design of Automation of Regional Power Grid Dispatching
- 18>DL548-1994 Management Regulations for Lightning Protection Operation of Power System Communication Stations
- 19>GB/T13729-2002 General technical conditions for telecontrol terminals
- 20>GB/T13730-2002 Regional Power Grid Dispatching Automation System
- 21>GB51048-2014 Design specification for electrochemical energy storage power station
- 22>GBT34120-2017 Technical Specification for Energy Storage Converter of Electrochemical Energy Storage System
- 23>GB/T20046-2006 Characteristics of grid interface of photovoltaic system (IEC61727:2004,

MOD)

24>GB/T 19939-2005 Technical requirements for grid connection of photovoltaic systems

2 System Design Scheme

Energy storage system:

A set of 30-foot container energy storage system is composed of battery compartment and electrical compartment. The battery compartment includes a set of 806.4kWh lithium iron phosphate battery energy storage system (including battery rack and BMS system); electrical compartment includes a 500kW energy storage converter , 1 set of energy management system (EMS) and auxiliary equipment.

The system topology is shown in Figure 2-1 below:

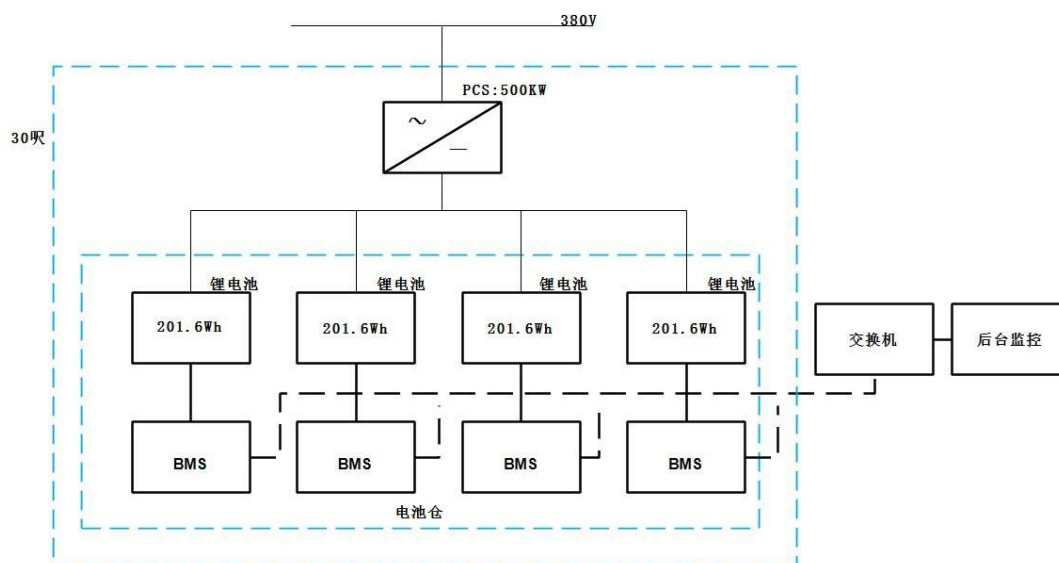

Figure 2-1 Topology of energy storage system (1)

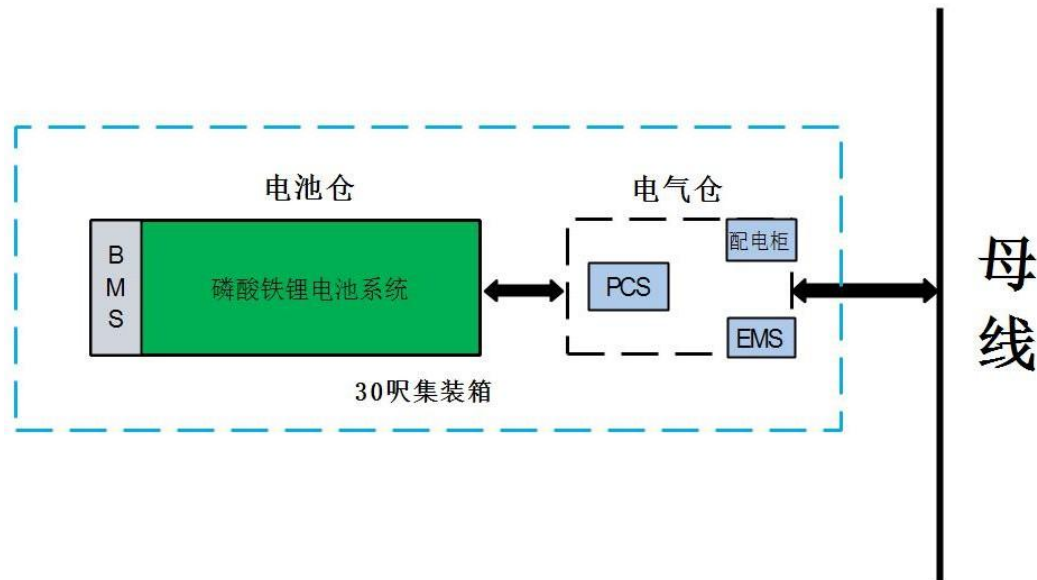

Figure 2-2 Topology of energy storage system (2)

A set of lithium iron phosphate battery energy storage system has a total capacity of 806.4kWh, using 3.2V280 Ah lithium iron phosphate batteries, 1P15S composed of a single module (48V280Ah), 1P225S composed of a cluster (720V280Ah), and four clusters composed of a system capacity of 806.4kWh.

2.1 Selection and design of energy storage converter (PCS)

2.1.1 Function Introduction of Energy Storage Converter

In the energy storage system constructed in this scheme, in addition to the bidirectional inverter function, the energy storage converter

At the same time, it can support the power grid, ensure the stable operation of the power grid system, provide the ability to resist short-term shocks, smooth power supply, and store energy.

The energy storage converter equipment adopts a modular design, each module is 62.5kW, and 5 modules are connected in parallel to form a 500kW energy storage converter.

The device topology adopts a three-level design. Compared with the two-level topology, the three-level topology can improve the switching frequency, conversion efficiency and system stability, reduce output harmonics, switching losses and converter volume.



Figure 2-3 500k PCS (for reference only)

2.1.2 500kW _ Selection Design of Energy S storage Converter

--

In this scheme, the energy storage converter adopts a single unit capacity of 500kW. The main topology of the circuit is shown in Figure 2-4.

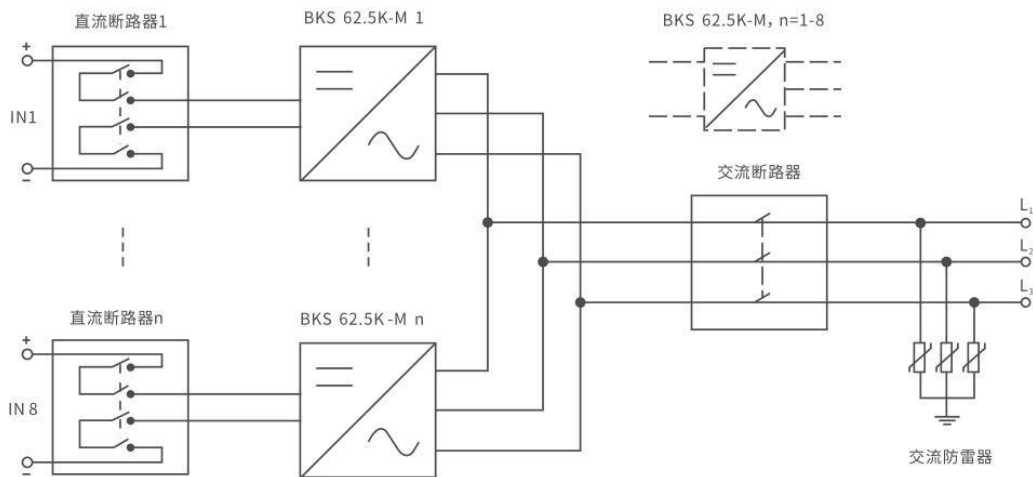

Figure 2-4 500kW energy storage converter system topology

Energy storage converter performance parameters:

Parameters of 500kW Energy S storage Converter

Product Model	BKS1-500K
DC side parameters	
DC voltage range	500~850V
DC maximum current	1128A
DC maximum power	500kW
AC grid connection parameters	
Rated output power	500kW
maximum apparent power	550kVA
Rated grid voltage	400V
Grid frequency range	50Hz/60Hz±2Hz
AC rated current	722A
Grid-connected power factor	-1~+1
System parameters	
The highest efficiency of the whole machine	97.50%
cooling method	Smart air cooling
noise	<65dB
temperature range	-30°C~55°C
Protection class	IP21
altitude	Derating above 3000m
Humidity range	0~95% no condensation
Size (width, height and depth)	1600*2050*1050mm
weight	2770kg
communication method	
show	Touch LCD display

BMS communication interface	RS485/CAN
local communication	RS485, TCP/IP

The energy storage converter has the following functions:

- (1) Grid connection function
 - a. When the lithium battery is connected, it is divided into two stages: constant power charging and constant current charging;
 - b. The grid-connected discharge can be controlled by preset or centralized monitoring and real-time scheduling;
 - c. Four-quadrant independent control of active and reactive power;
 - d. In cooperation with the grid dispatching system, peak regulation can be performed according to the historical curve or real-time load
- (2) Realize peak shaving and valley filling of the power grid;

Under the dispatch of EMS (Energy Management System), electricity can be stored when the electricity consumption is low, and the electricity can be released when the electricity consumption peaks, so as to reduce the peak-to-valley difference of the power grid, improve the load characteristics of the power grid, and realize the load level control and load transfer of the power system.

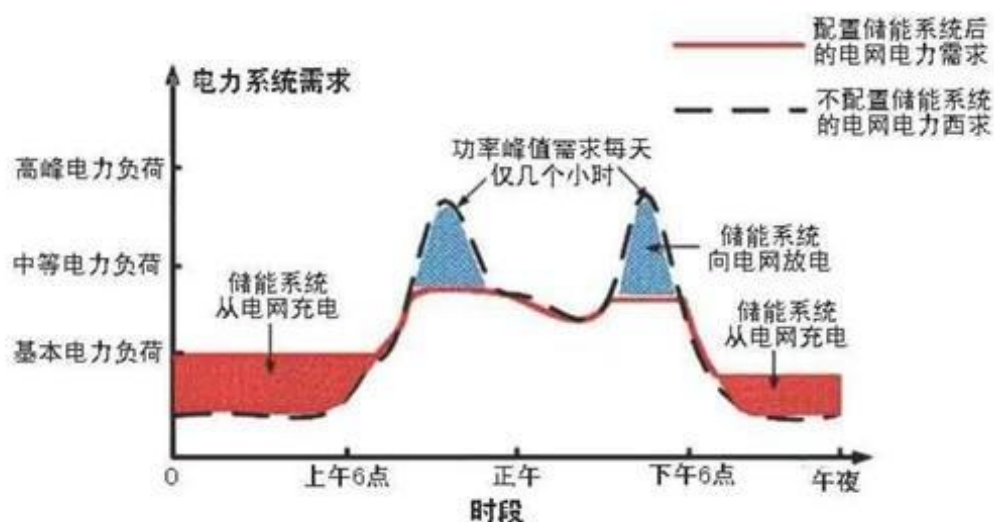

Figure 2-5 shaving peaks and filling valleys

2.1.3 Energy Storage Converter Protection Strategy _ _ _

For the PCS protection strategy, meet the relevant standards for the access of the distributed generation system to the power grid ,

It has but is not limited to the following protection functions:

- (1) Abnormal protection of grid voltage and frequency;
- (2) Island protection;
- (3) Output overload and short circuit protection;
- (4) Output DC component control;
- (5) DC overvoltage and reverse connection protection;
- (6) Low-voltage ride-through protection;
- (7) Restore grid-connected protection;
- (8) Power recovery rate control;

At the same time, according to the BMS requirements of different batteries, the battery side charge and discharge conditions are protected according to its control strategy, including overcharge, overdischarge, capacity protection, etc.

PCS monitors as follows:



Figure 2-6 PCS monitoring (1)



Figure 2-7 PCS monitoring (2)

Remotely implement app management functions:



Figure 2-8 Schematic diagram of the app (1)

Figure 2-9 Schematic diagram of the app (2)

2.1.4 Dimension and installation design of 500KW energy storage converter

The converter is installed in a vertical cabinet (W1600mm*D1050mm*H2050mm), and the system adopts the cooling method of forward air and back air.

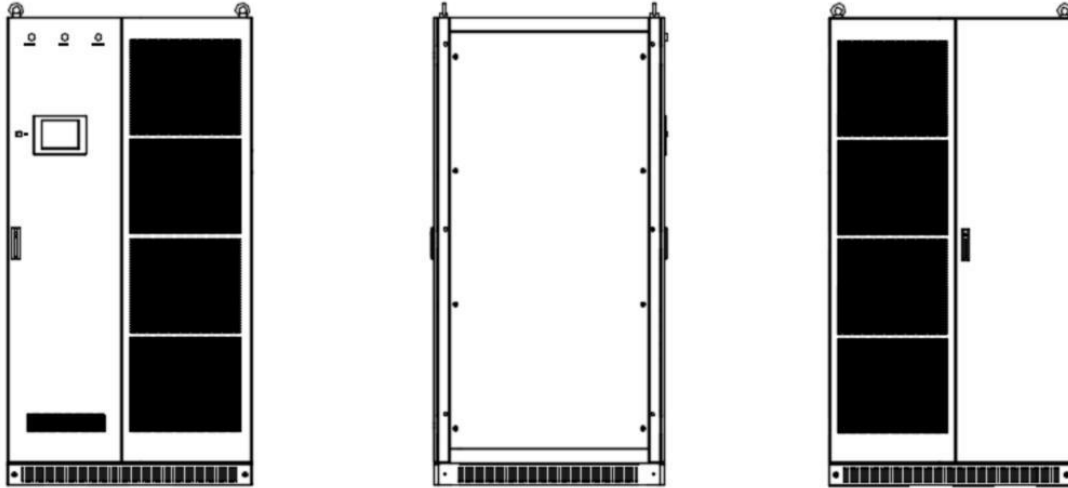

Figure 2-10 Dimensional drawing of 500kW energy storage converter

2.2 Energy Management System (EMS) Design

2.2.1 EMS Introduction to system functions

The energy management system is an important part of the energy storage system. It provides data management, monitoring, control and optimization for the microgrid dispatch control center to ensure the stable and efficient operation of the energy storage system. The energy management system can receive the instructions of the superior dispatching system, and can also monitor the operation of each equipment in the container system.

2.2.2 EMS Network architecture

In the energy storage system, the EMS communication topology is divided into two layers. The top layer is the total centralized monitoring system, and the bottom layer equipment: a 500kW energy storage converter, battery management system (BMS), environmental monitoring equipment, fire protection system, air conditioning, etc. Access the monitoring system.



Figure 2-11 Schematic diagram of EMS system (for reference only)

The monitoring host completes the network connection, conversion, data acquisition, data local processing, protocol conversion and command exchange between the on-site measurement and control systems, local user screen monitoring operation, control strategy, and realizes the high-speed collection and transmission of large-capacity real-time data to ensure the master station. The system can quickly and accurately obtain all monitoring and monitoring information, and timely feedback system abnormalities and faults detected by the network to ensure rapid positioning and recovery.

2.2.3 EMS Functional Design

(1) Real-time monitoring of power station operation

The system can collect real-time and timing data for all monitored operating parameters and states, process important historical data and store them in the database. Including: total voltage, current, average temperature, SOC, SOH, charge and discharge current and power limit of each group of batteries in the BMS system, single-cell maximum battery voltage, single-cell maximum battery temperature, fault and alarm

information, historical charge put

Common information such as electric power, historical charge and discharge power, etc.

PCS related parameters, including: voltage/current/power of each branch on the DC side, active power, reactive power, voltage, current, power factor, frequency and temperature of each phase on the AC side, cabinet temperature, operating status, alarm and Common information such as fault information, as well as daily charge capacity, daily discharge capacity, cumulative charge capacity, cumulative discharge capacity, etc. Information such as voltage, current, active power, reactive power, frequency, etc. of each phase of the load.

(2) Display of power station operation data

The system can customize the relevant data required by the system to the specified interface according to user requirements, view real-time data and historical data, and export reports;

(3) Real-time dispatching and remote dispatching of power stations

According to the difference in system demand data between the on-site monitoring layer and the general control center, the field equipment layer of the micro-grid power station can freely configure the data to be uploaded to the on-site monitoring layer and the central control center, or it can be processed and screened by the on-site monitoring layer and uploaded to the general control center. . The protocol supports MODBUS.

(4) Fault alarm

The system provides recording and query functions for events at all levels,

and uses colors to distinguish and manage event types and importance.

(5) Report, real-time curve, energy flow display

The system provides real-time curve recording, analysis and query functions, freely select the data to be recorded and analyzed, and display real-time data, historical data and historical data statistical values with curves and bar graphs. The statistical data interval is 5 minutes, 15 minutes, and 1 hour. and 1 day. The system can customize various reports, analysis charts, and export according to user requirements.

2.2.4 EMS Technical Data Sheet

Table 2-2 EMS technical parameter table

No.	Technical parameter name	parameter
1	Synthetic error of analog telemetry	<1.5%
2	In-Site Sequence of Events Recording Resolution (SOE)	≤2ms
3	The annual correct action rate of remote signaling at the time of accident	>99%
4	System availability	>99.9%
5	System mean time between failures (MTBF) of which I/O unit module MTBF>50000h	>20000h
6	Mean time between failures of measurement and control units at bay level	>40000h
7	The average CPU load rate of each workstation:	
	Normal (within any 30min)	<30%
	When the power system fails (within 10s)	<50%
8	Monitoring system network average load rate:	
	Normal (within any 30min)	<30%
	When the power system fails (within 10s)	<50%
9	History curve sampling interval	1min ~ 30min adjustable
10	Historical curve daily and monthly report storage time	21 years
11	Remembrance of the accident:	
	Before the accident	1min
	after the accident	2min
12	Dual host switching time	<30s
13	System capacity:	
	Number of access plants	>1024
	number of states	>400000
	Number of analogs	>600000
	Quantity of electricity	>200000
	Number of remote controls	>20000
The number of remote adjustment	>20000	

2.3 Container layout design

According to the calculation of this scheme, the 30-foot container can basically meet the actual system requirements. The actual design shall prevail. The container size is the recommended specification:

9274mm (W)*2438mm (D)*2896mm (H).

Area analysis: The container is about 9.3 meters long, 2.5 meters wide and 2.9 meters high.

A space of 3 meters should be reserved between the length and width to facilitate crane installation and subsequent maintenance.

The project covers an area of about 68 square meters.

2.4 System Cooling Scheme _ _

The main equipment in the electrical room is the PCS and EMS systems, which can be air-cooled for heat dissipation.

2.5 Fire Protection System Scheme

The battery room adopts a cabinet-type heptafluoropropane fire extinguisher to ensure that the entire battery room is filled with gas within 8s to effectively extinguish the fire. At the same time, it is equipped with a sound and light alarm system and a gas discharge indicator .

Considering that the protection of the cabinet is relatively complete, the electrical warehouse has perfect overheat protection, short circuit protection, etc., fire is a very extreme working condition, and there is a smoke sensor. Once an alarm signal is detected, the system will be shut down, and a dry powder fire extinguisher can be used here as a backup. Extinguishing.

2.5.1 Working principle of cabinet type heptafluoropropane fire extinguisher system

- (1) Scheme: 1 system is equipped with 1 alarm controller (2 loops, 1 bus disk, 2 network cards), a total of 2 manual alarm buttons, 1 sound and light alarm, and 1 deflation indicator Lamp and 3 I/O modules only.
- (2) Workflow: The fire alarm controller determines the corresponding storage location to report the fire according to the specific location of the fire signal. The corresponding manual alarm button and the point button of the bus panel on the alarm are on, indicating that it is in a fire alarm state, and

at the same time, the corresponding manual alarm button is turned on. The device sound and light siren action. If the fire alarm controller is in the manual state at this time, you can press the on-site corresponding manual

The Alarm Button or the Corresponding Bus Control Panel Button On the Fire Alarm Controller in the Control Room Starts the Action of the Selection Valve Corresponding to the STORAGE LOCATION of the Equipment; if in the Automatic State, The Alarm Directly Starts the Action of the Selection valve corresponding to the storage location of the corresponding equipment; when the alarm controller receives After the feedback signal of the selection valve is received, the controller starts the action of the bottle group control module, and starts the bottle head valve to open to extinguish the fire. After the fire alarm controller receives the feedback signal from the bottle head valve of the bottle group, the on-site control box will start the action of the deflation indicator light, indicating that the deflation is not allowed to enter.

2.5.2 Introduction to the main functions and components of each part of the system

(1) fire alarm controller

The controller adopts a modular design idea. The system consists of multiple CPUs to form a real-time working system. Different functional partitions are managed by dedicated CPUs. Each module is completely independent and communicates with each other by system bus. The main CPU processes , calculates and judges the data collected by the CPU of each circuit board, and determines the operation status of the addressing units on each circuit board and each bus. It is saved in the system, and the sound and light alarms are activated at the same time, and the corresponding actions of the field equipment are activated through the preset linkage

relationship. The alarm device communicates with each disk, loop card, communication card and network card through the bus, receives the alarm information from each disk and card, and controls the action and information transmission of the disk. Complete fire alarm detection, display, alarm, processing and linkage control of field equipment.

(2) Gas release A lamp _

The gas release alarm (herein after referred to as the alarm) is a new product developed in accordance with GB 26851-2011 "Auditory and/or Light Alarms for Fire", and is equipped with a gas fire extinguishing controller.

It is installed in a prominent position at the entrance and exit of the gas protection zone. When the gas fire extinguishing control device is activated, the alarm will flash and display the words "Do not let gas enter". Alert on-site personnel. Ensure personal safety.

(3) Fire sound and light alarm

The fire sound and light alarm is a product developed in accordance with the requirements of GB26851-2011 "fire sound and/or light alarm". It has a built-in central processing unit, electronic coding, and is connected to the fire alarm controller (linkage type). After the fire is confirmed at the scene, a strong sound and light alarm signal will be issued to remind the on-site personnel to pay attention.

2.5.3 Technical parameters of main equipment

(1) fire alarm controller

Table 2-3 Rated operating conditions of fire alarm controller

No.:	Name _	Conditions of Use
1	Ambient temperature	0 ~ 40 °C
2	Relative humidity	≤ 95 % (40 ± 2 °C)
3	DC backup	DC12V (two sections) 12Ah
4	Main power	AC220V (187V ~ 242V) 50Hz ± 1%
5	Alarm Current and Voltage	3A/24V
6	Linkage Current and Voltage	3A/24V(Independently isolated from the alarm power supply)



Figure 2-12 Product appearance diagram (for reference only)

Main Specifications:

- ① Relay contact capacity 2A 30VDC or 1A 125VAC;
- ② Up to 3 circuit boards can be connected, each circuit board contains 2 circuits, each circuit has 198 points;
- ③ The maximum capacity of a single machine is 198×6 detectors and modules;
- ④ Fire alarm, fault, resettable relay normally open and normally closed contact output;
- ⑤ The system can connect up to 2 bus manual control panels;
- ⑥ The system can connect up to 2 multi-line linkage control panels;
- ⑦ A single machine can connect up to 64 fire display panels;
- ⑧ Can be connected to a graphic display device;
- ⑨ Can be connected to 10 fire extinguishing controllers;
- ⑩ It can be networked with the alarm controller;

(2) Gas release alarm

Table 2-4 Gas Release Alarm Rated Service Conditions

No.:	Name _	Conditions of Use
1	Rated voltage	DC24V
2	Quiescent Current	$\leq 200\mu\text{A}$
3	Alarm current	$\leq 100\text{mA}$
4	Flash frequency	1Hz~2Hz
5	ambient temperature	$\leq 100\text{mA}$
6	Executive standard	GB26851-2011 《Fire Sound and/or Light Siren》
7	Dimensions	325mm long x 149mm wide x 39mm thick

(3) fire sound and light alarm

Table 2-5 Rated operating conditions of fire sound and light alarm

No.:	Name _	Conditions of Use
1	ambient temperature	-10°C~50°C
2	Relative humidity	5%~95%RH, No condensation
3	Operating Voltage	Rated voltage DC24V
4	Rated current	Static $\leq 350\mu\text{A}$ Working $\leq 50\text{mA}$
5	sound pressure level	75~95dB
6	pitch period	3s~5s
7	Basic flash frequency	1Hz~2Hz
8	Input /Output module	KM8302
9	ambient temperature	KM8302
10	Relative humidity	KM8302
11	Operating Voltage	DC20.4V~DC26.4V
12	Rated current	Static 350uA Alarm 3mA
13	Output characteristics	Active DC24V
14	Input characteristics	Active DC24V
15	Executive standard	GB16806-2006
16	Certification mark	CCC

2.6 Access control system and lighting scheme

All containers are equipped with conventional lighting and emergency lighting, which cooperate with the access control system. When the door is opened, the conventional lighting is turned on. After the door is closed, the conventional lighting is turned off. When the door is opened and the conventional lighting is powered off, the emergency lighting is turned on, and the emergency lighting time is guaranteed to be no less than 30 minutes.

2.7 Introduction of Lithium Battery

Lithium-ion batteries have the advantages of high energy density, high conversion efficiency, long cycle life, no memory effect, no charge and discharge delay, low self-discharge rate, wide operating temperature range and environmental friendliness, so they become an ideal carrier of Electric Energy., Widly Use in Various Fields. With the Intensification of Environmental Protection PROBLEMS In Recent Years, as the best substitute for lea D-ACID BATTERIES, The Application Trend of Lithium Batteries beCome More and More Extensive. Compared with the low element density of lithium titanate and the danger of ternary lithium, the application of lithium iron phosphate has become the preferred configuration for power applications. In addition, compared with the application of traditional lead-acid batteries, lithium batteries have a safer application solution

, The lithium battery pack is equipped with a lithium battery management system (herein after referred to as BMS) with various protections.

2.7.1 Main parameters of battery cells

Table 2-6 Main parameters of battery cells

No.:	Specifications	3.2V280Ah
1	Material Type __	LFP
2	Battery model	BK32280
3	Dimensions	Width: 173.90±0.80mm Thickness: 71.80±0.50mm Height: 204.60±0.80mm

		Overall height: 207.30±0.8mm
4	Weight eight	≤5.6kg
5	Factory Internal Resistance	≤0.25mΩ
6	Rated Capacity	280Ah
7	Rated voltage	3.2V
9	Charge cut-off voltage	3.65V
10	Discharge cut-off voltage	2.5V
11	Maximum charging current	1.0C
12	Maximum discharge current	1.0C

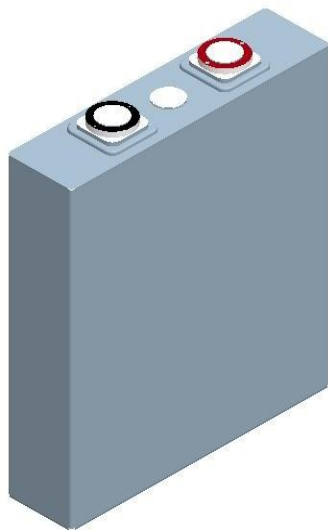

Figure 2-13 Cells (for reference only)

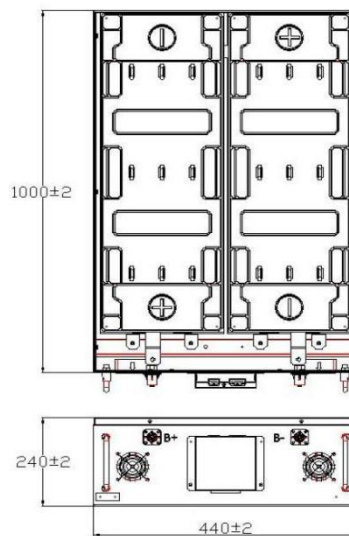

Figure 2-14 Module size (for reference only)

2.7.2 Battery Pack and Clustering

The battery arrangement scheme of the 806.4kWh battery system is shown in Table 2-7 below:

Table 2-7 806.4kWh battery system battery allocation and rental scheme

type	Model/parameter	Minimum voltage/V	Maximum voltage/V	Rated voltage/V	Energy/Wh	quantity
Cells	280Ah	2.5	3.65	3.2	896	900
Single Battery Pack	1P15S	37.5	54.75	48.0	13440	15
Battery Cluster	1P225S	562.5	821.25	720.0	201600	4
ESS Systems	4*1P225S	562.5	821.25	720.0	806400	1

Table 2-8 Battery Box Dimensions PACK Clustering

No.:	Project Name	Specifications	Remark
1	System Grouping __	1P225S	4 battery groups
2	Rated Capacity	280Ah	
3	Rated voltage	DC720V	
5	voltage range	562.5V~821.25V	
6	Rated energy	201.6kWh	
7	Maximum continuous charge current	140A	(0.5C)
10	best working temperature	20°C~35°C	
12	size	W1000*D1100*H2000 mm	

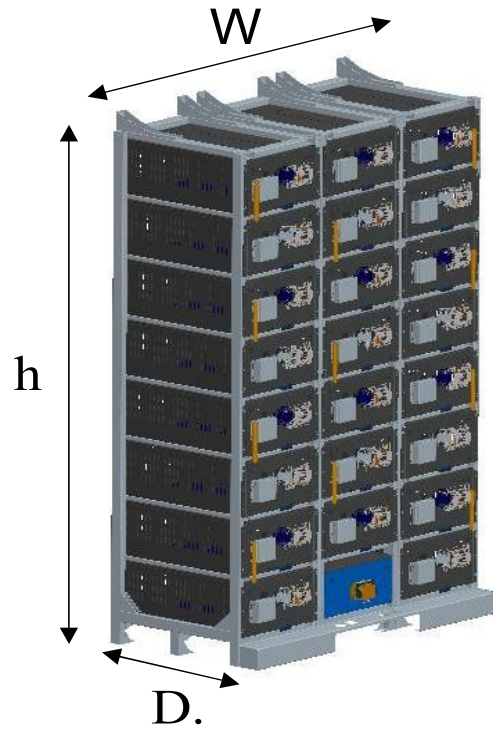

Figure 2-15 Schematic diagram of battery cluster (for reference only)

2.8 Battery Management System (BMS)

2.8.1 Topology Diagram

The battery management system (BMS) is a three-level network architecture. Each battery box is managed by a battery management unit (BMU) to the battery cell. The BMU is responsible for the battery cell voltage, temperature collection, balance and other functions. The BMU uses CAN bus to communicate, and the cell information (cell voltage, temperature and cell SOC) of the battery is sent by the BMU.

Each battery cluster is equipped with a high-voltage box, which contains a battery pack control unit (BCMU), which collects the total voltage and current of the battery cluster and controls the battery cluster contactor, and conducts data communication (CAN communication) on the battery cluster.

Each battery unit is equipped with a battery management system man-machine interface (BAMS),

The battery information uploaded by the group control unit (BCMU) is processed, and it has the functions of display, parameter setting, fault alarm, data recording, etc., and communicates with the PCS and the monitoring background. For PCS:

Fault dry contact, normally closed, fault disconnected;

For the controller: fault dry contact, normally closed, fault disconnected;

For the mains charger: fault dry contact, normally closed, fault disconnected.

The battery management system (BMS) system architecture is shown in Figure 2-16 below:

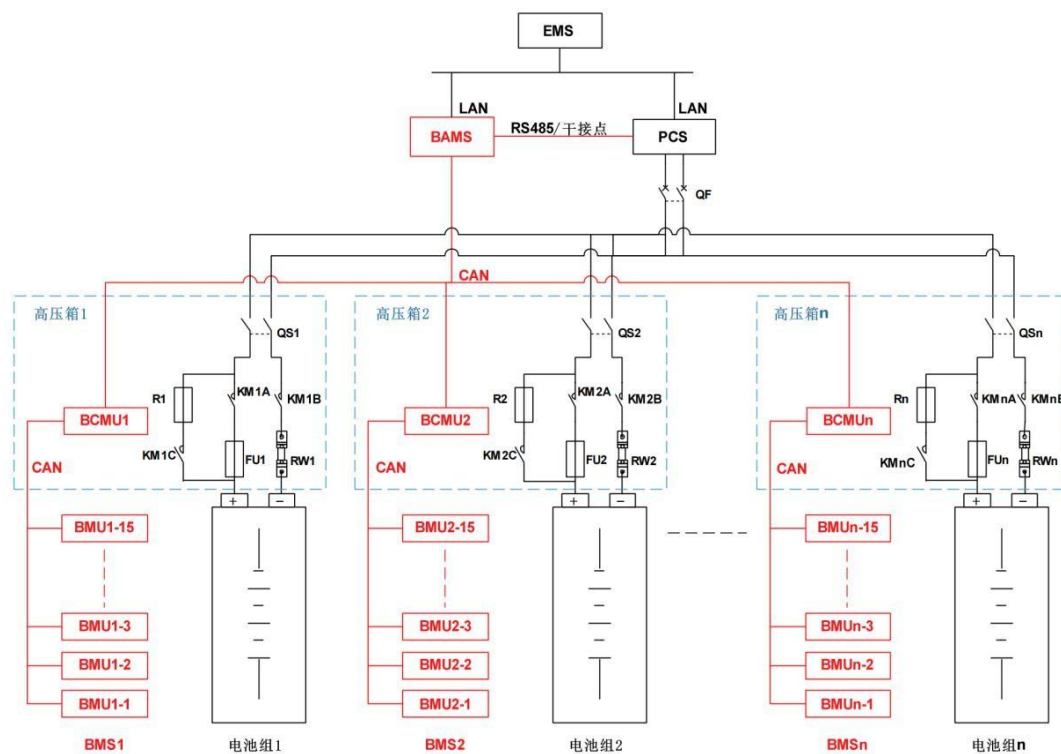

Figure 2-16 BMS topology

2.8.2 BMS function description

The battery management system is a real-time monitoring system for energy storage batteries, which effectively monitors battery voltage,

battery current, battery cluster insulation status, battery SOC, battery module and cell status (voltage, current, temperature, SOD, etc.) Safe management of charging and discharging process,

Alarm and emergency protection for possible faults, safe and optimal control of the operation of battery modules and battery clusters, to ensure safe, reliable and stable operation of batteries.

2.8.3 Composition and function description of BMS battery management system

The battery management system consists of the battery module management unit BMU and the battery cluster management unit BCMU and its current, voltage and temperature detection units.

The BMS system has the following functions:

(1) Analog measurement function: It can measure the voltage and temperature of the single cell in real time, and measure the voltage and current of the battery pack terminal. Ensure the safe, reliable and stable operation of the battery, ensure the service life of the single battery, and meet the requirements for the optimization and control of the operation of the single battery and the battery pack.

(2) Online SOC diagnosis: On the basis of real-time data collection, a multi-mode segmentation processing method is used to establish an expert mathematical analysis and diagnosis model, and the remaining power SOC of each battery is measured online. At the same time, The SOC prediction is

intelligently corrected according to the discharge current of the battery and the ambient temperature, etc., and the remaining capacity and reliable use time of the battery more in line with the changing load are given.

(3) Battery system operation alarm function: when the battery system is in overvoltage, undervoltage, overcurrent, high temperature, low temperature, abnormal communication, abnormal BMS, etc., the alarm information can be displayed and reported.

(4) Battery system protection function: For abnormal battery failures such as severe overvoltage, undervoltage, and overcurrent (short circuit) that may occur during operation, the high-voltage control unit can quickly cut off the battery circuit, isolate the fault point, and output in time. Sound and light alarm information to ensure the safe and reliable operation of the system.

(5) Communication function: The system needs to have the communication function with the energy storage converter (RS485), and the communication function with the integrated monitoring and management system (LAN).

(6) Thermal management function: Strictly monitor the operating temperature of the battery pack. If the temperature is higher or lower than the protection value, a thermal management start signal will be output. The system can be equipped with a fan or a heat preservation and heat storage device to adjust the temperature; The battery management system automatically links with the system protection mechanism to cut off the battery circuit in time to ensure the safety of the system.

(7) Self-diagnosis and fault-tolerant function: The battery management system adopts advanced self-fault-diagnosis and fault-tolerant technology, and has self-checking function for the software and hardware of the module itself. Even if the internal fault or even the device is damaged, it will not affect the safety of battery operation. There will be no failure of the energy storage system due to the failure of the battery management system, or even damage to the battery or a vicious accident.

(8) The BMS has the function of self-diagnosis, which can self-diagnose faults such as interruption of communication between the BMS and the outside world, abnormal internal communication of the BMS, and abnormal acquisition of analog quantities, and can report it to the local monitoring system.

(9) Balance function: passive balance, balance current 100mA.

(10) Operation parameter setting function: BMS operation parameters should be able to be modified remotely or locally in the BMS or energy storage station monitoring system, and some parameter modifications require password confirmation.

(11) Local operating state display function: BMS can display various operating states of the battery system locally, such as system state, analog information, alarm and protection information, etc.

(12) Event and log data recording function: BMS can locally store 10,000 events and log data of the battery system in a certain amount.

(13) There are two types of personnel in the operation interface of the BMS system. The operating personnel and the installation personnel have their own authority and password settings.

The BMS parameter table is as follows:

Table 2-9 BMS parameters

No.:	Parameter _	Parameter Value _ _	Remark
1	Working Power _	DC12/24V	/
2	Balanced way	Passive equalization	/
3	Voltage A acquisition A accuracy	$\leq 0.5\%$	/
4	Current A acquisition A accuracy	$\leq 0.5\%$	/
5	Temperature A acquisition A precision	$\leq 2^{\circ}\text{C}$	/
6	SOC deviation	$\leq 8\%$	/
7	Voltage A acquisition C cycle	$\leq 200\text{ms}$	/
8	Current A acquisition C cycle	$\leq 100\text{ms}$	/
9	Temperature Collection C cycle	$\leq 100\text{ms}$	/
10	Voltage balance Balance Balance	$\leq \pm 50\text{mv}$	/
11	Protect	Overcharge, O verdischarge, O vertemperature, short circuit	Protection value can be set
12	Way of Communication _	Ethernet, CAN, RS485	/
13	Letter of A greeting	Modbus	/

3 System Installation _ _

The overall security process of the container energy storage system is as follows:

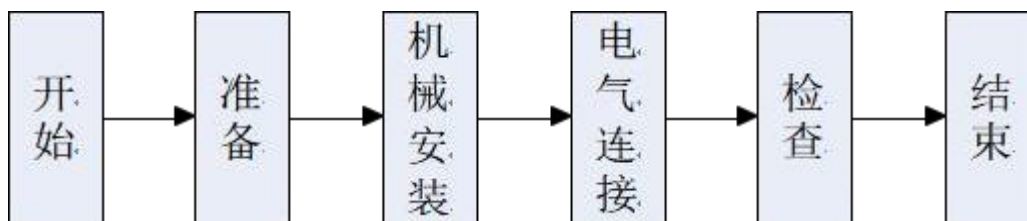

Table 3-1 Installation process description

Installation Steps	Installation Notes	Remark
Installation preparation	<ul style="list-style-type: none"> ● Check the container shell, door and fan cover for damage ● Check whether the equipment inside the container is damaged or loose ● Check whether the accessories are complete 	
	<ul style="list-style-type: none"> ● Whether the installation environment meets the requirements ● Is there any equipment for lifting containers on site? ● Are the installation tools complete? 	
Mechanical installation	<ul style="list-style-type: none"> ● Use hoisting equipment to move the container to the base position for installation ● Welding and fixing the container and the foundation ● Remove the protective film of the dust net 	
Electrical connections	<ul style="list-style-type: none"> ● Grounding system connection ● AC cable connection ● Communication cable connection 	
examination	<ul style="list-style-type: none"> ● Installation inspection of electrical wiring parts ● something else 	

3.1 Installation preparation

3.1.1 Inspection before installation

Table 3-2 Pre-installation inspection of containers

Check parts	Eligibility criteria	Unqualified treatment method
Each fastening bolt (screw)	The bolts (screws) are not loose, and the tightening marks are not offset	Tighten the bolts (screws), if the bolts (Screw) sliding wire, replace with new standard parts

Check parts	Eligibility criteria	Unqualified treatment method
Internal cabinet fixing	All cabinets are firmly fixed without offset	Contact the manufacturer for secondary tightening
wire terminal	Use the wire of the cold-pressed terminal to check by hand that it is not loose on the terminal	Tighten the bolts (screws)
container appearance	The exterior paint is normal without peeling off, and the appearance has no deformation	Repainting, repair of deformed parts

3.1.2 Installation tools and parts

Install the required tools:

- Lifting crane;
- Relevant supporting facilities and accessories required for welding process;
- Screwdrivers, wrenches, torque wrenches;
- Wire strippers, terminal crimping tools, hot hair dryer;
- Multimeter.

3.2 Mechanical installation

3.2.1 Mechanical installation requirements

- Environmental requirements

The construction site must meet the installation environment requirements required by the following table:

Table 3-3 Installation Environment Requirements

Project	require	
working conditions	Installation site	Ground inclination ≤ 1 degree; anti-seismic capacity ≤ 8 : horizontal $\leq 0.4g$, vertical $0.2g$; vertical installation on a solid foundation in the room, the cooling medium is air
	Ambient Temperature	$-35^{\circ}\text{C} \sim +60^{\circ}\text{C}$, the air temperature change is less than $0.5^{\circ}\text{C}/\text{min}$
	Relative Humidity	$0\% \sim 95\%$, no condensation due to temperature change
	Other Climatic	No icing, rain, snow, hail, etc., air pressure $70-106\text{kPa}$;

Conditions _	
Dust and Solid P article Content	Sand: <30mg/m ³ ; Dust (floating) <0.2 mg/m ³ ; Dust (deposition) <1.5 mg/(m ² .h);

● Mechanical dimensions

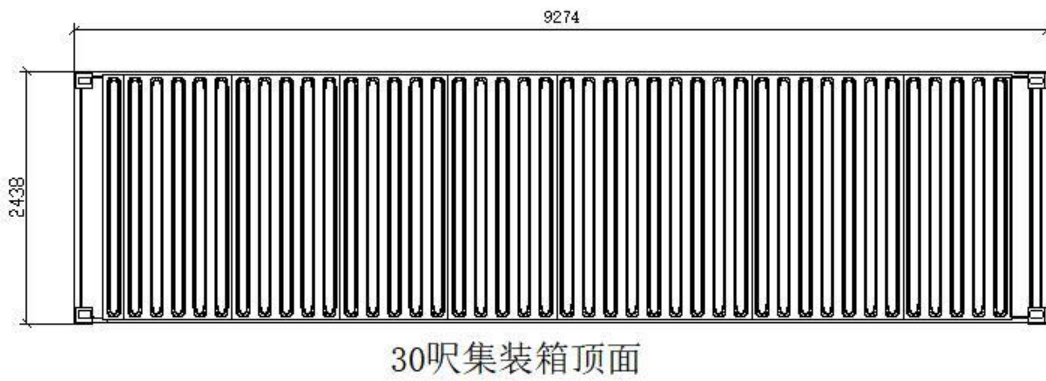
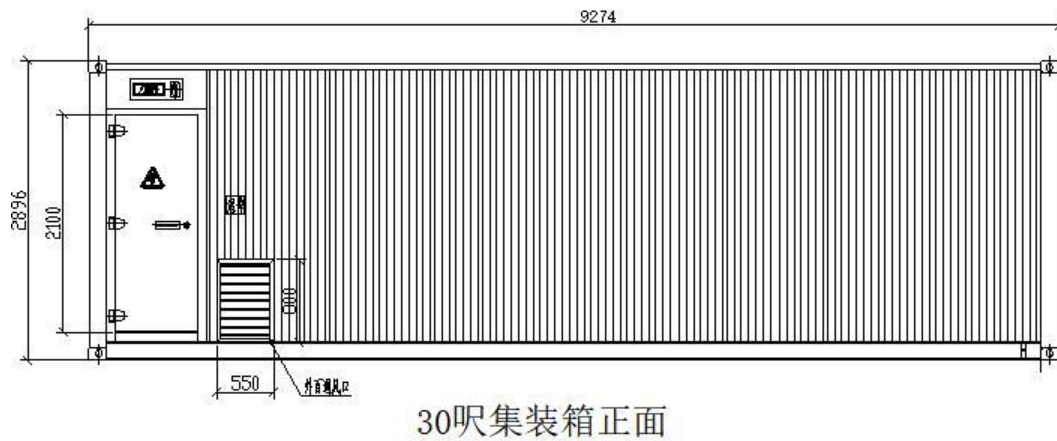

Figure 3-1 Dimensions of 30-foot energy storage container

● Foudation Requirements

The foundation map of the container energy storage system adopts different foundation methods according to the site conditions. The specific construction drawings shall prevail. This scheme only introduces two conventional foundation schemes: :

Scheme 1: Effect drawing of steel structure support foundation



Figure 3-2 Effect drawing of steel structure support foundation (for reference only)

Method Option 2: Effect drawing of cement foundation



Figure 3-3 Effect drawing of cement foundation foundation (for reference only)

- Hoisting requirements

The total weight of the container energy storage system exceeds 22 tons, and the crane with an effective lifting capacity of more than 50 tons can be fully loaded

enough for hoisting needs. Use wire rope with end fittings on the corner fittings on the top of the crane bottom to

Lift and transfer at an angle of $\leq 60^\circ$. Or use 2 cranes with an effective lifting capacity of more than 25 tons to lift the corner fittings at both ends of the container respectively, and carry out lifting and transfer as shown in Figure 4- 4 below.

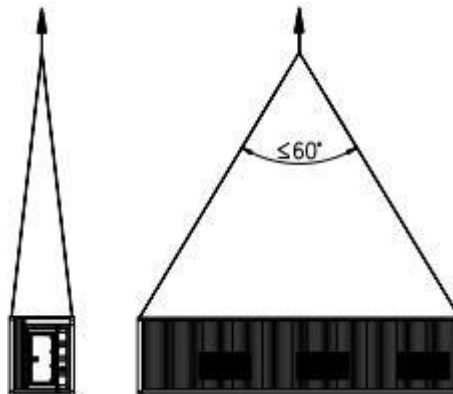

Figure 3-4 Schematic diagram of container lifting (for reference only)

Check and confirm the work before lifting operation:

- (1) The construction site has been leveled, and the transportation road is unobstructed;
- (2) The foundation of the crane station site is checked and correct.
- (3) The construction of the equipment foundation has been completed and has been officially handed over to the installation;
- (4) The hoisting organization is sound and the personnel are in place.
- (5) The test hoisting and the arrangement of all machine riggings are in good condition and meet the requirements of the plan;
- (6) The hoisting area should be isolated from the warning area by a safety cord, and persons unrelated to hoisting are strictly prohibited from entering;
- (7) The hoisting weather meets the requirements.
- (8) The construction site has been leveled, and the transportation road is unobstructed;

Hoisting method:

(1) Use lifting lugs for hoisting

(2) At the beginning of hoisting, the crane slowly lifts the hook and conducts test hoisting. During the test hoisting process, it must be carefully checked, and if there is no abnormality, the preparation for formal hoisting begins

When the official hoisting begins, the crane slowly lifts the hook until the container is about 400mm off the ground, rotates the boom, and adjusts the direction of the container.

- Container installation and fixation

After the container is hoisted to the foundation, the following points should be paid attention to when fixing:

- (1) Before fixing, the position of the incoming and outgoing lines of the container must be considered, and it should be adjusted in time according to the needs during installation;
- (2) After the container is placed in place, the four corner posts of the container and the iron plate on the cement foundation or the steel structure foundation shall be reliably connected by continuous seam welding, and spot welding is not allowed;
- (3) After the welding is completed, the welding seam needs to be effectively painted or treated with anti-rust treatment to prevent rusting and affect the service life of the container frame.

3.3 Electrical installation

3.3.1 Grounding system connection

Two grounding points are reserved for the container body, which are connected to the original grounding network. If foreign objects or rust are found on the grounding bar when connecting the grounding wire, please grind it before connecting the grounding wire, and spray anti-rust paint.

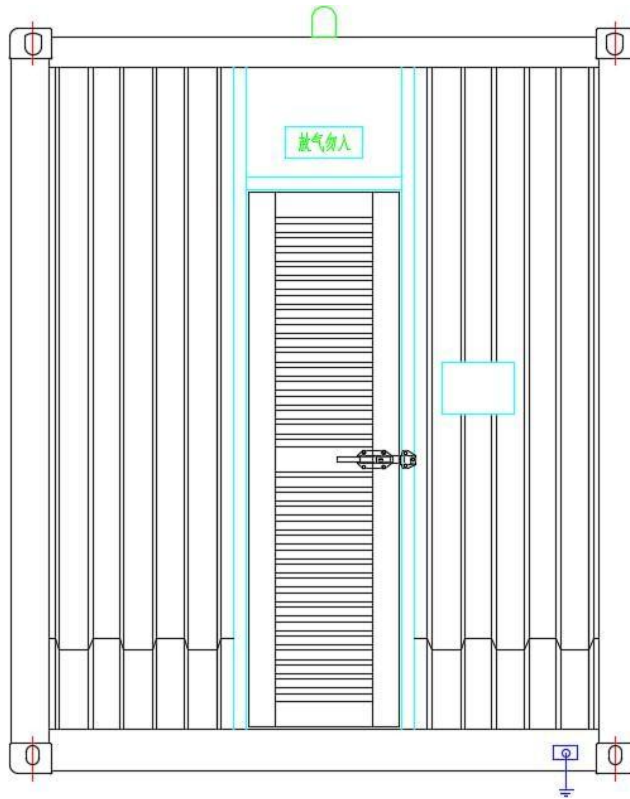

Figure 3-5 Grounding diagram (for reference only)

Screw specification: M8*25, quantity: 2.

3.3.2 AC Cable Connection

A wiring hole is reserved on the AC side of the container energy storage system, and the cable joints must be cold-pressed. Recommended cable selection:

2 4-core 240mm² cables, cold-pressed end SC240-16;

3.3.3 Communication cable connection

The container energy storage system reserves a communication cable port, which can be connected to a network communication line.

4 .Equipment list

Table 4-1 Equipment List

No.:	Name _	model	Parameters and Specifications	unit	Quantity	Remark
1	500kW energy storage container box one body machine	BKS1-500K		set	1	The energy storage integrated machine includes 1.1, 1.2, 1.3, 1.4, 1.5, 1.6, 1.7 ,s even part s .
1.1	Energy storage Converter	BKS1-500K		set	1	
1.2	Energy storage 能源 manage system	EMS-A7 book ground controller		set	1	
1.3	30 feet container box shell		Length, width and height (9274mm*2438mm*2896mm), including low-voltage, communication power compartment, AC output main cabinet, control cabinet (UPS power supply, power transformer, etc.), connecting copper bars, etc., including cooling fan, air duct, emergency lighting, Smoke detection, air conditioning, fire protection; outer box protection grade IP54	set	1	
1.4	Single 3.2V/280Ah Batteries	LFP BK32280		PCs	900	

1.5	Battery Manage _ System BMS			set	4	
1.6	Confluence Cabinet _			PC	1	
1.7	Battery Shelf _			PC	4	