



# RTPOWER 48V 230AH LIFE PO4 BATTERY PACK SPECIFICATION & USER MANUAL

**Note : Please kindly read this manual carefully before operating and keep it for future reference.**



Functions	Configuration
External Switch	Y
Current Smiting	Y
Display Screen	Y
Data Storage	Y
Pre-charging	Y
Communication	CAN
Multi-trip	Y

# CONTENT

1. Introduction .....	4
2. Function .....	4
3. Product Information .....	5
4. Communication.....	7
4.1 CAN.....	7
4.2 RS485.....	7
4.3 Parallel Communication .....	8
4.4 DIP Address .....	8
5. Working Mode .....	9
6. Indicators .....	10
6.1 LED Indicator Introduction .....	10
6.2 Capacity Light .....	10
6.3 Indicator Blinking Type.....	11
6.4 Indicator Status .....	11
7. Installation .....	12
7.1 Cargo List .....	12
7.2 Installation Environment .....	13
7.2.1 Check Battery Status .....	13
7.2.2 Installation Positioning .....	13
7.2.3 Wiring .....	14
7.2.4 DIP Address Settings .....	15
8. Packing .....	17
9. Safety Precaution .....	18
10. Electrical Safety.....	19
11. Environment Safety.....	19

## 1. Introduction

The 48V 230Ah battery system is applicable to home energy storage, small or medium sized shopping mall energy storage, which uses 15 pieces of 3.2V 230Ah battery cells in 15s1p configuration. Built-in smart BMS support maximum of 15 packs of battery in parallel to achieve higher capacity. The system can not be connected in series. And do not mix use a RTPower battery with any other battery brands or models.

## 2. Function

- C14-cell battery voltage sampling test, with deviation of  $\pm 20\text{mV}$ .
- Battery and ambient temperature detection: 4 battery temperature sensors, 1 ambient temperature sensor, and 1 MOS temperature sensor, with a deviation of  $\pm 2^\circ\text{C}$ .
- Battery capacity and cycles: Complete a full charge/discharge cycle to set the actual capacity. The remaining capacity of the battery is monitored with a capacity estimation accuracy within 5% deviation. Additionally, charge and discharge cycle times as well as full charge and discharge cycle times are configurable.
- Intelligent cell balancing: The charging and static balancing strategies can be set flexibly to effectively extend the service life.
- Communication port: PC or smart front-end can monitor battery pack data, control operation and set parameters through commands such as telemetry, remote signaling, remote adjustment, and remote control. The communication protocol conforms to the requirements of YD/T 1363.3, and realizes cascade communication at the same time.
- History data recording, saving and reading: Battery condition and alarm

information will be recorded and save in real time when there is abnormality in the battery. A maximum of 500 history failure data can be stored.

- Battery management system parameter setting: Battery management system parameters includes cell over-voltage/under-voltage, battery total voltage over-voltage/under-voltage, charging/discharging over-current, battery high/low temperature, battery capacity, working mode, charging/discharging current limiting and so on. They can be set in the battery monitor system.
- Working mode: Working modes including charging/discharging current limiting, fixed voltage output, direct output and so on.
- Multiple protection functions: Hardware protection, battery protection, high/low temperature protection, output short-circuit protection and so on.

### 3. Product Information

#### 3.1 Dimension and Port

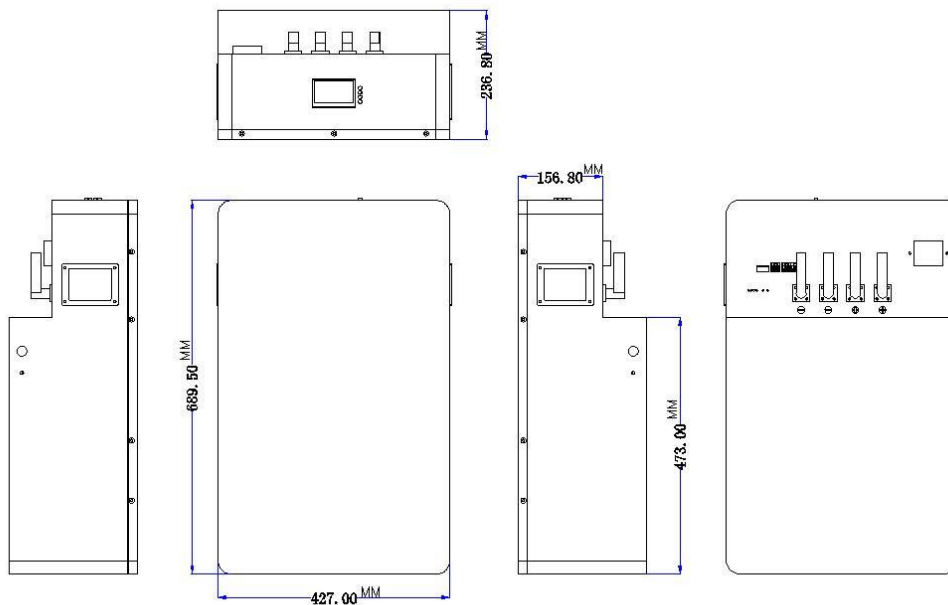

### 3.2 Electrical Schema

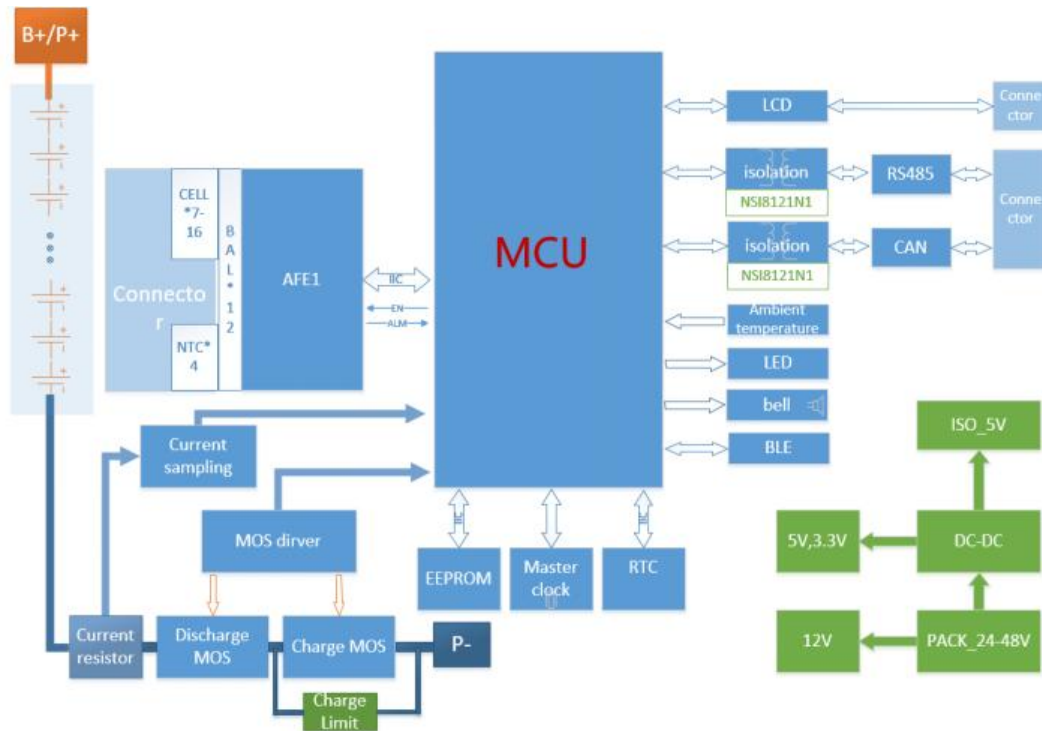

### 3.3 Battery Performance Parameter

1	Battery Configuration	1P15S
2	Nominal Voltage	48V
3	Working Voltage Range	39V~54V
4	Nominal Capacity	230Ah
5	Nominal Power	11KWh (95%DOD)
6	Standard Charging/Discharging	Current 100A @25±2°C
7	Maximum Charging Current	200A@25±2°C
8	Maximum Discharging Current	200A @25±2°C
9	Working Ambient Temperature	0~40°C(Charge) 20~40(Discharge)
10	Storage Temperature & Humidity	10°C~35°C (within 1 month storage) 25±2°C (within 3 months storage) 65%±20%RH
11	Size (L x W x H)	654*593*253MM
12	Weight	95kg
13	Cycling Lifespan	6000 cycles @25°C 100A Charging/discharging current 80%DOD
14	IP Rate	IP 30
15	Communication	CAN or RS485
16	Altitude	0-3000m
17	Humidity Range	5~80%

## 4. Communication

### 4.1 CAN

BMS has the function of battery pack upload CAN communication, with the baud rate of 500K. CAN communication port adopts 8P8C network cable port. It can communicate with inverter or CAN TEST through CAN port. When the battery pack is connected, the RS485 communication is used to connect, and the battery pack data, status and information are uploaded to the PCS through CAN communication.

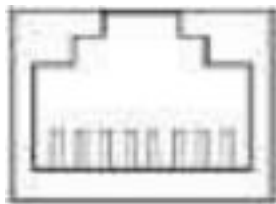

INVCOM

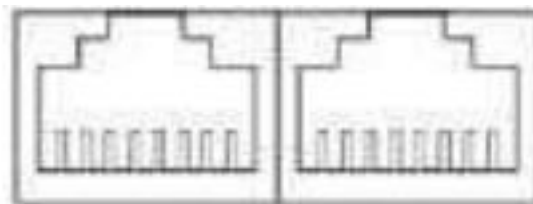

BATCOM

#### **CAN Communication Port Definition:**

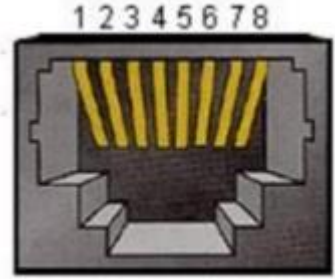
Quote	Definition Interpretation	
1,2,7,8	NC	
4	CAN-H	
5	CAN-L	
3,6	Ground	

### 4.2 RS485

BMS has RS485 communication with battery pack set, with the baud rate of 19200bps. The RS485 communication interface adopts 8P8C network cable interface.

### RS485 communication port definition:

Quote	Definition Interpretation
1,8	RS485-B
2,7	RS485-A
3,6	Ground
4,5	NC (hung in the air)

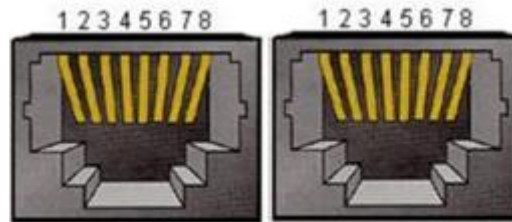

### 4.3 Parallel Communication

When multiple machines are connected in parallel, the RS485 port is used as the parallel communication port, and the CAN port is used as the uplink communication port. The terminal device can read the sum of all parallel PACK battery data through the CAN port. When multiple machines are connected in parallel, the connection of the RS485 interface is shown in the following figure:

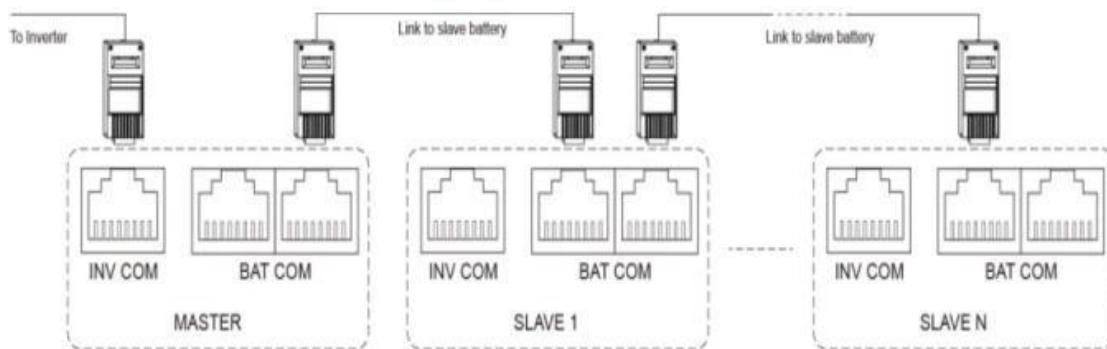

### 4.4 DIP Address

Parallel DIP Switch Definition: In the multi-computer communication when the battery packs are connected in parallel, the DIP switch is use to distinguish different Pack addresses, and the hardware address can be set through the



DIP switch on the board. DIP switch bit1 to bit8 definition: Bit1 to bit4 are used to set the address, and bit5 to bit8 are used for the number of slaves. Master Device Setting: Bit1 to bit4 are 0, the master address is fixed to 0, and bit5 to bit8 are set according to the number of parallel slaves. (as in Table 2)

Slave Device Setting: Bit1 to bit4 are set according to the device order, and the slave address range is 1 to 15. Bit5 to bit8 are fixed to 0. (as in Table 1)

Parallel use address setting: refer to the following table for the definition of the DIP switch



## 5. Working Mode

### 5.1 Charging Mode

When the BMS detects that the charger is connected and the external charging voltage is greater than the internal battery voltage by more than 0.5V, MOSFET charging will be on. When the charging current reaches the effective charging current, it enters the charging mode. When in charging mode, MOSFET charging and discharging are closed.

### 5.2 Discharging Mode

When BMS detects that there is load connection and the charging current reaches effective discharging current, it gets into discharging mode.

### 5.3 Standby Mode

When it is neither of the modes above, it gets into standby mode.

### 5.4 Power Off Mode

BMS gets into turn-off mode when standing by for 48 hours, battery under pressure protection is triggered, turning off by button or exterior switch.

Turning off mode activation conditions:

1. Charging activation;
2. Activation with 48V voltage;
3. Manual turn-on

## 6. Indicators

### 6.1 LED Indicator Introduction

1 operation light, 1 alert light, 4 capacity signal lights

●	●	●	●	●	●
SOC				ALARM	RUN

### 6.2 Capacity Light

State		Charging				Discharging			
Capacity	Signal	L4●	L3●	L2●	L1●	L4	L3	L2	L1
Capacity	0 ~ 25 %	Off	Off	Off	Blinking	Off	Off	Off	On
	25 ~ 50 %	Off	Off	Blinking	On	Off	Off	On	On
	50 ~ 75 %	Off	Blinking	On	On	Off	On	On	On
	≥75 %	Blinking	On	On	On	On	On	On	On
Running	Signal Light●	On				Blinking			

### 6.3 Blinking Information

Blinking Way	On	Off
1 Blink	0.25s	3.75s
2 Blinks	0.5s	0.5s
3 Blinks	0.5s	1.5s







### 6.4 Indicator Status

System Condition	Operation State	RUN	ALM	SOC				Interpretation
		●	●	●	●	●	●	
Turn-off	Sleeping	Off	Off	Off	Off	Off	Off	All being off
Standby	Normal	Blinking	Off	Off	Off	Off	Off	Standby state
Charging	Normal	On	Off	Referring to Capacity Signal				Top LED blinks twice
	Over Current Alert	On	2 Blinks	Referring to Capacity Signal				Top LED blinks twice
	Over Pressure Protection	1 Blink	Off	Off	Off	Off	Off	
	Temperature and over current protection	1 Blink	Off	Off	Off	Off	Off	
Discharging	Normal	3 Blinks	Off	Referring to Capacity Signal				Referring to power turn-on signal
	Alert	3 Blinks	3 Blinks					
	Temperature, over current, short-circuit protection	Off	On	Off	Off	Off	Off	Stop discharging. Compulsory sleeping when there is no activity after it is offline for 48 hours

Under pressure protection	Off	Off	Off	Off	Off	Off	Off	Stop discharging
---------------------------	-----	-----	-----	-----	-----	-----	-----	------------------

## 7 Installation

### 7.1 Cargo List

NO.	Name	Quantity	Picture
1	Battery Pack	1 PCS	
2	Wall-mount Bracket	1pcs	
3	Wall mounting screw	2pcs	
4	Expansion screw	2pcs	
5	Battery connection cable	2pcs	
6	Ethernet cable	1pcs	
7	Gloves	1 pair	

## 7.2 Installation Environment

### 7.2.1 Check Battery Status



### 7.2.2 Installation Positioning

- Do not assemble the battery in combustible architecture material.
- Assemble the battery to solid wall and level it with eyes level so the LCD display screen can be read any time.
- Keep the temperature between 10°C and 30°C to maintain the best operation state. A vertical installation against the wall is recommended.
- There should be space for dissipation around the battery (as shown below). This applies to concrete surface or other incombustible surface.
- Mark the four fixed positions of the sockets. Anchors should be upward with an angle of 10° to prevent falling down.



### 7.2.3 Wiring

Battery should be turned off before connection

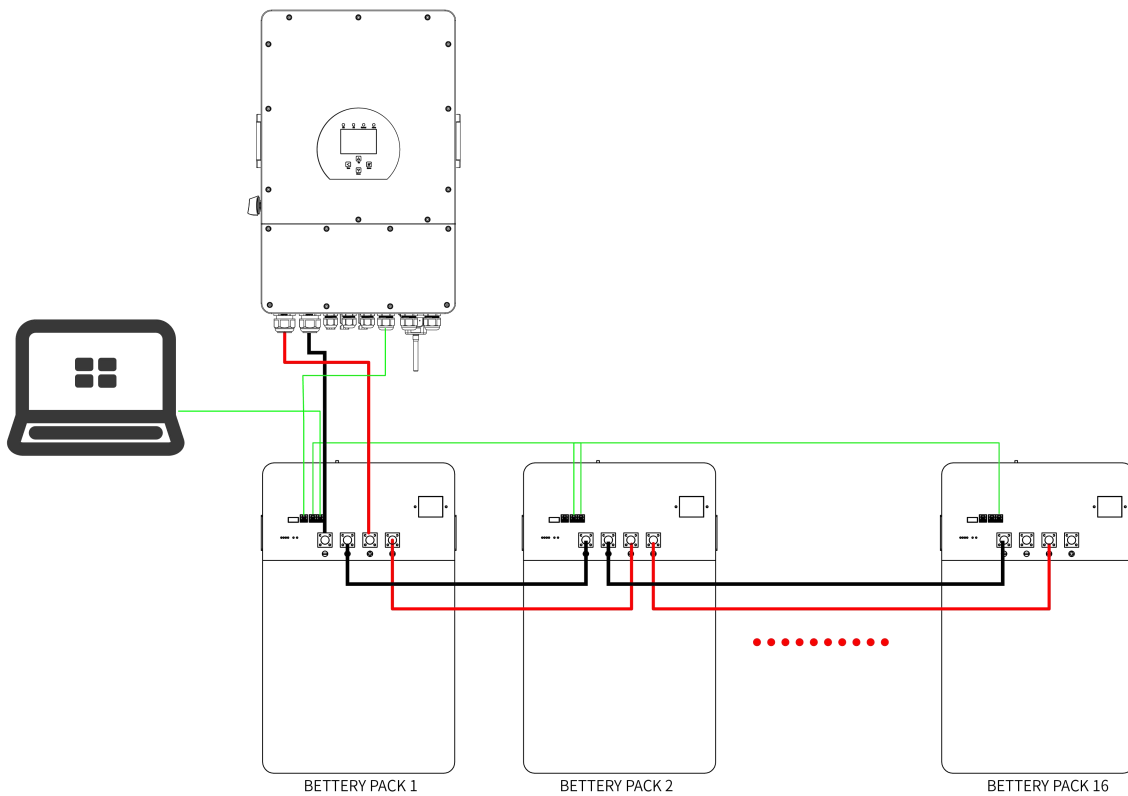

## 7.2.4 DIP Address Settings

ON OFF

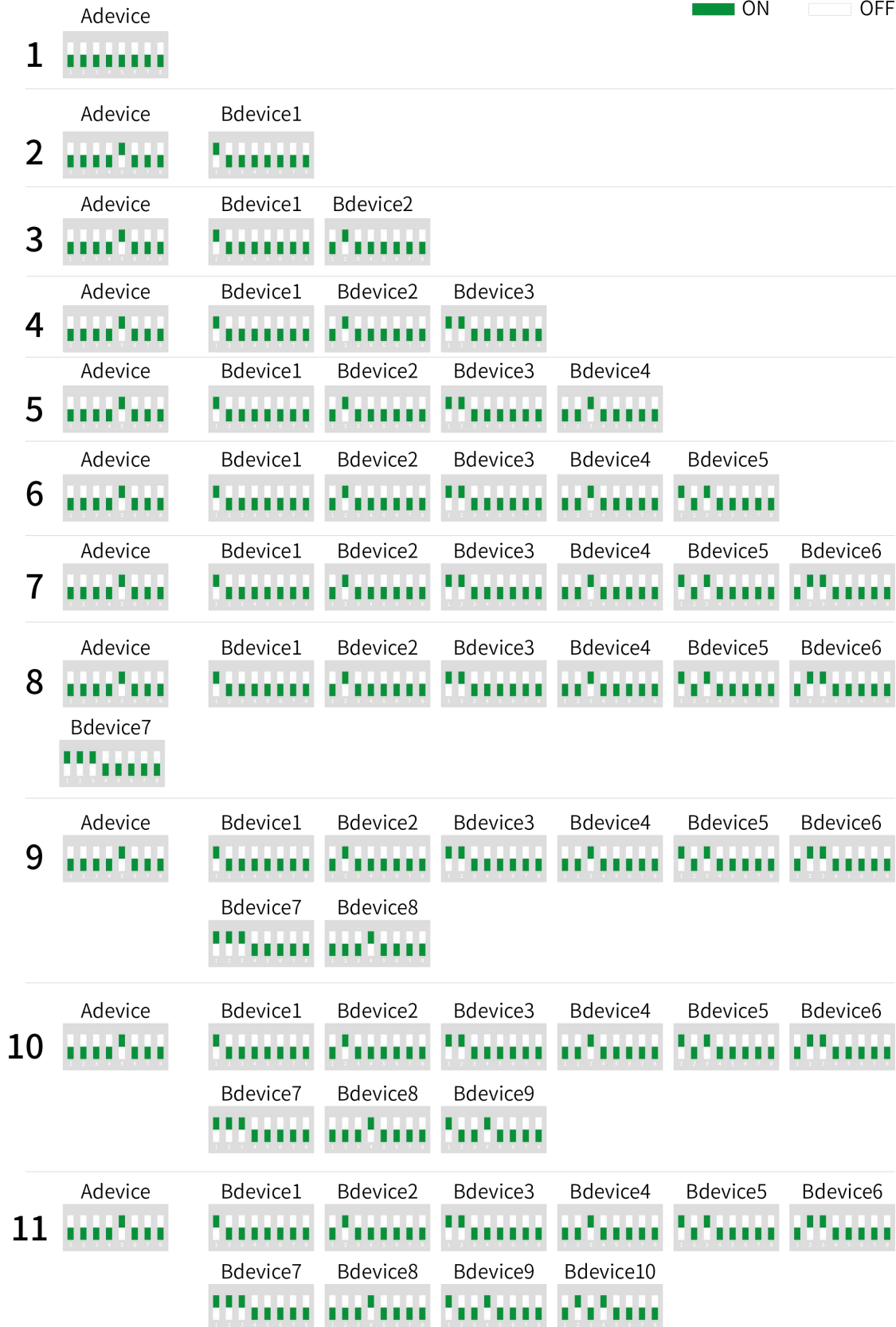

■ ON □ OFF

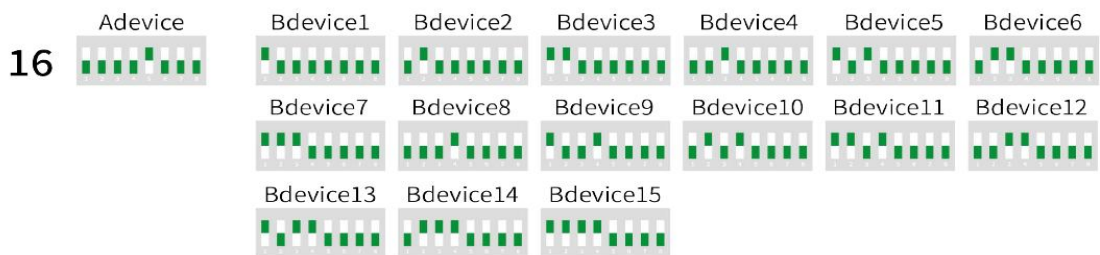
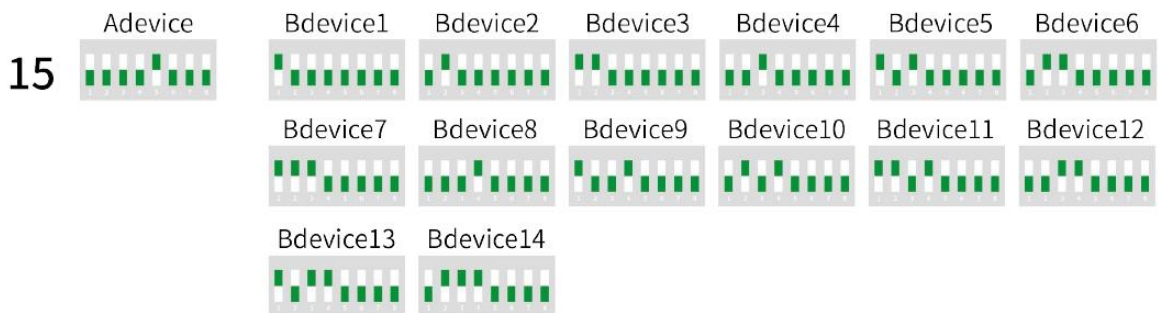
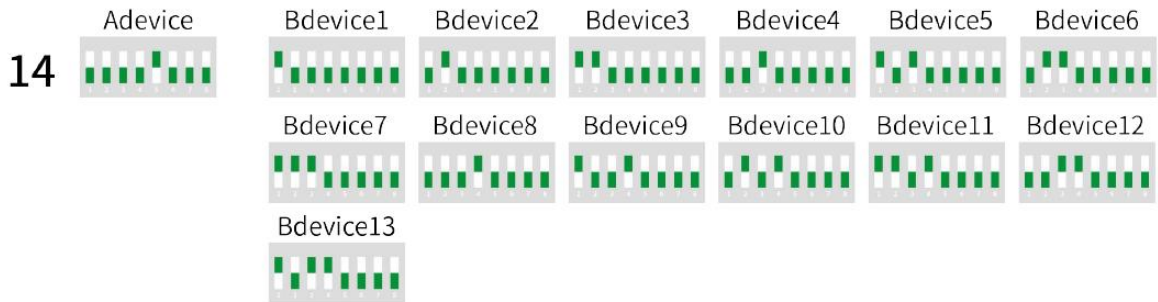
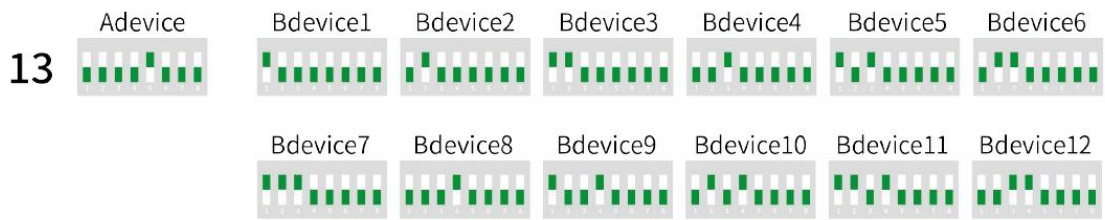
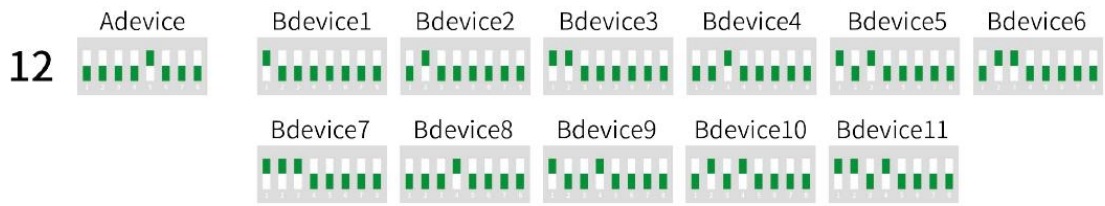



## 8. Packing

Pack it in a dry, dust-proof and moisture-proof box. Pack the product with plastic film/EPE and pack it in a wooden box.

Specification: L 0.49m\*W 0.3m\*H 0.85m 1Pc Weight: 110kg



## 9. Safety Precaution







- Do not use the battery if there is any obvious impact or deformation.
- Do not stack multiple batteries.
- Pay attention to the polarity of power source or the connection ends
- Use tools and apparatus properly and insulate the device properly.
- Battery installation sites should be away from fire sources or combustible objects.
- It is strictly prohibited to plug or unplug any kits from the device when it is running.
- It is prohibited for non-technicians to open any function modules. Anyone violating this rule is at his/her own risk.
- Please fully charge the battery with specialized charger before using the new battery or using it for a long duration.
- Do not assemble, open, squeeze, bend, deform, pierce or break the product.
- Do not retrofit the battery or plug it to any other exterior objects. Do not soak the product or expose it to liquids like water, fresh or salty, or beverage (coffee, juice and so on).
- Do not short-circuit the battery or contact the battery contact ends with metal or other conductors.
- Do not drop the battery. If it happens(especially dropping to the hard ground), please contact the service center.
- If there is any electrolyte leakage, make sure the battery make no contact with skin or eyes. If they have contact, please wash the contact area with fresh water or seek help from the doctors.
- Do not disassemble the cell battery in any circumstance. It may lead to internal short circuit or even cause fire or other problems.

- Do not burn the battery or put it in the fire in any circumstance. Otherwise, it may cause battery burning.

## 10. Electrical Safety

### Symbols on battery

There are some electrical symbols on battery relate to electrical safety. Please make sure you have fully understand them before installation.

	<i>Electrical danger</i>	<i>Voltage exists when the battery is powered on. Only qualified engineers are allowed to operate.</i>
	<i>Earth connector</i>	<i>Earth connection.</i>
	<i>DC positive and negative connectors</i>	<i>Identify positive and negative connectors of DC power source.</i>
	<i>CE mark</i>	<i>The product meets CE certification.</i>
	<i>WEEE tag</i>	<i>Can't leave battery as garbage disposal.</i>
	<i>Recycle</i>	<i>Battery can be recycled</i>

## 11. Environment Safety

### Wall Mounted Lithium Battery Series

#### User Manual



- Ensure that the equipment is installed in a dry and well- ventilated environment.
- The installation position must be away from direct sunlight and rain.

- The installation position must be far away from fire sources.
- The installation position must be far away from water sources such as taps, sewer pipes, and sprinklers to prevent water seepage.
- The bracket must be installed solidly and horizontally.
- Do not expose the equipment to flammable or explosive gas or smoke.  
Do not perform any operation on the equipment in such environments.
- The operation and service life of the battery depends on the operating temperature. Operate the battery at a temperature equal to or better than the ambient temperature. The recommended operating temperature range is from 0° C to 30°C.

