

Product Model

POW-HV2.5K-12V-EU

POW-HV3.5K-12V-EU



# POWMr

PURE SINE WAVE INVERTER

User Manual

## Important Safety Instructions

Please keep this user manual for future reference!

**⚠ WARNING:** You must read, understand, and follow all safety instructions in this document. Failure to follow safety regulations may result in property damage or personal injury.

### Basic Guidelines

1. Before using the device, carefully review all instructions and warning labels on the device, battery, and in the manual.
2. This product does not contain user-serviceable parts. Do not disassemble the device. If repair or cleaning is needed, send it to a qualified service center. Improper reassembly may lead to short circuits and fire hazards. Do not remove the front panel or operate the product if any panel shows a fault. All operational steps must be performed by qualified personnel. The warranty will be void if the inverter is tampered with.
3. To reduce the risk of electric shock, disconnect all wiring before performing any maintenance or cleaning. Simply turning off the device does not eliminate the risk of electric shock.
4. Warning: Only qualified personnel should assemble this device with the battery pack.
5. Exercise extreme caution when working with metal tools or around batteries, as dropped tools can spark, short-circuit the battery or other electrical parts, and potentially cause explosions.
6. When disconnecting AC or DC terminals, strictly follow the installation procedures outlined in the manual.
7. Before using this product, read the provided instructions to become familiar with safety features and operating guidelines. This product is designed and tested to international standards and must be used only for its intended purpose.

### Installation and Wiring

1. Do not use this product in areas with gas or dust explosion hazards. Consult the battery manufacturer before use to ensure compatibility. Always follow the battery manufacturer's safety instructions.
2. Avoid contact with foreign objects or liquids. Do not touch the inverter with wet hands. Keep the product out of reach of children.
3. Grounding Instructions: The inverter must be connected to a permanent grounding system to

- ensure compliance with local requirements and regulations. If grounding protection is suspected to be damaged, turn off the product to prevent accidental electric shock.
4. To achieve optimal inverter performance, adhere to the required specifications and select appropriate cable sizes, which is crucial for proper operation.
  5. Carefully check that the battery voltage matches the inverter's input DC voltage (12V). Voltage mismatches between the inverter and battery may cause severe damage.
  6. Reversing the positive and negative terminals between the inverter and the battery is strictly prohibited, as it will burn the inverter's fuse.
  7. Avoid using excessively long battery cables, as they can cause voltage drops and reduce efficiency.
  8. Ensure the device is used in compliant environmental conditions. Do not operate the product in humid or dusty environments. Ensure adequate space around the product and keep ventilation openings unobstructed.
  9. Before starting the device, verify all connections are correct and securely fastened.
  10. This inverter cannot be used in parallel with others and must not be connected to the public electricity grid.
  11. When the inverter is not in use, turn off the power and disconnect it from the system to prevent battery drain.

### Transport and Storage

1. Ensure all power cables are disconnected before storing or transporting the product.
2. If the device is transported without its original packaging, any transport damage will not be covered.
3. Store the product in a dry environment with a storage temperature range of  $-10^{\circ}\text{C}$  to  $45^{\circ}\text{C}$ .

## Table of Content

Important Safety Instructions.....	1
1 Overview.....	3
1.1 Scope.....	3
1.2 Intended Audience.....	3
1.3 Manual Usage.....	3
2 Product Description.....	4
2.1 Features.....	4
2.2 Basic System Architecture.....	4
2.3 Product Appearance.....	5
3 Installation.....	6
3.1 Unpacking Inspection.....	6
3.2 Installation Tools.....	6
3.3 Installing the Device.....	7
4 Wiring.....	8
4.1 Cable Size and Breaker Specifications.....	8
4.2 Enclosure Grounding.....	8
4.3 Battery Connection.....	9
4.4 Remote Control Panel Connection.....	10
5 Operation.....	11
5.1 Starting the Inverter.....	11
5.2 Connecting Loads.....	11
5.3 Remote Control Panel Overview.....	12
6 Protection Functions.....	13
7 Troubleshooting.....	14
8 System Maintenance.....	15
8.1 Damage Disclaimer:.....	15
8.2 Non-Warranty Conditions:.....	15
9 Specifications.....	16

# **1 Overview**

## **1.1 Scope**

This user manual provides product information, operation, and maintenance guidelines for the POW-HV-EU series inverters. The POW-HV-EU series products, developed by PowMr, are versatile inverters suitable for a wide range of residential and commercial applications.

## **1.2 Intended Audience**

This manual is intended for professional technicians involved in the installation, operation, and maintenance of lithium batteries, as well as end users seeking technical information.

## **1.3 Manual Usage**

1. Before using the product, carefully review this user manual and keep it in a readily accessible place.
2. All information in this user manual, including images and symbols, is the property of PowMr. Unauthorized use of any part or the entirety of this manual by non-company personnel is prohibited.
3. Considering the possibility of updates and revisions to this manual, users should refer to the product's included instructions as a reference. Users can obtain the latest user manual through the official website or by contacting customer service.

## 2 Product Description

### 2.1 Features

1. Pure sine wave inverter output.
2. Inverter output power up to 2500W/3500W.
3. Suitable for converting 12VDC to 220V  $\pm$  10% AC output.
4. Supports double surge output for 1 seconds.
5. Built-in USB port with output up to 5V 2.4A.
6. Built-in overload, short circuit, over-temperature, under-voltage, over-voltage, and reverse polarity protection.
7. Equipped with a remote control panel for easy remote monitoring of data and status.

### 2.2 Basic System Architecture

The diagram below illustrates the basic application of the inverter.



For other possible system architectures, please consult with your system integrator based on your requirements.

## 2.3 Product Appearance



①	Power Switch	⑤	USB Port
②	LCD Display	⑥	AC Output Ports
③	Communication Port	⑦	Battery Ports
④	Indicator Light	⑧	Fans

## 3 Installation

### 3.1 Unpacking Inspection











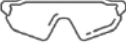

Before assembly, carefully inspect the package to ensure that the items inside are undamaged.

You should receive the following items in the package:

- Inverter device x1
- User manual x1
- Battery cables x2
- Remote control panel x1
- Dedicated communication cable x1
- Spare replacement fuses (6 PCS for 2.5K model, 8 PCS for 3.5K model)
- Battery terminal screw kit (1 pair)

### 3.2 Installation Tools

Prior to installation, prepare the following tools:

Category	Tools		
General Tools	Multimeter 	Protective gloves 	Insulated safety shoes 
	Protective clothing 	Safety goggles 	Antistatic wrist strap 
Installation Tools	Electric screwdriver 	Socket wrench 	Wire stripper 
	Phillips screwdriver (M4/M6) 	Electric drill 	Hammer 



### 3.3 Installing the Device

Before choosing an installation location, consider the following points:

- Do not install the inverter on combustible building materials.
- Install it on a solid surface.
- For proper air circulation and adequate heat dissipation, leave approximately 150cm of space on both sides, the top, and the bottom of the device.
- The ambient temperature should be maintained between  $-10^{\circ}\text{C}$  and  $45^{\circ}\text{C}$  to ensure optimal operation.
- Ensure that other objects are positioned at a safe distance from the inverter surface as shown in the example diagram, to allow for proper heat dissipation and sufficient space for wiring removal.

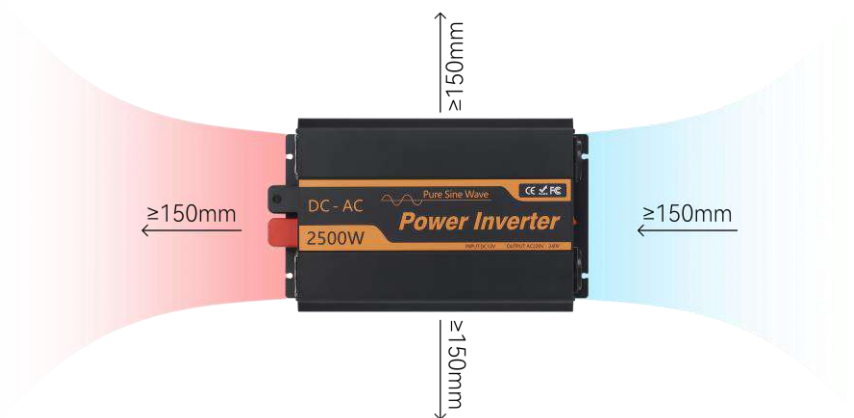

**Note:** Only suitable for installation on concrete or other non-combustible walls.

To install the unit, use 4 screws. It is recommended to use M4 or M5 screws.

## 4 Wiring

### 4.1 Cable Size and Breaker Specifications

#### ➤ Battery

Model	Gauge	Circuit Breaker Spec
POW-HV2.5K-12V-EU	3AWG	250A
POW-HV3.5K-12V-EU	2AWG	300A

#### ➤ AC Output

Model	Gauge	Circuit Breaker Spec
POW-HV2.5K-12V-EU	13AWG	15A
POW-HV3.5K-12V-EU	13AWG	20A

### 4.2 Enclosure Grounding

Please follow the diagram below to complete the grounding of the inverter enclosure.

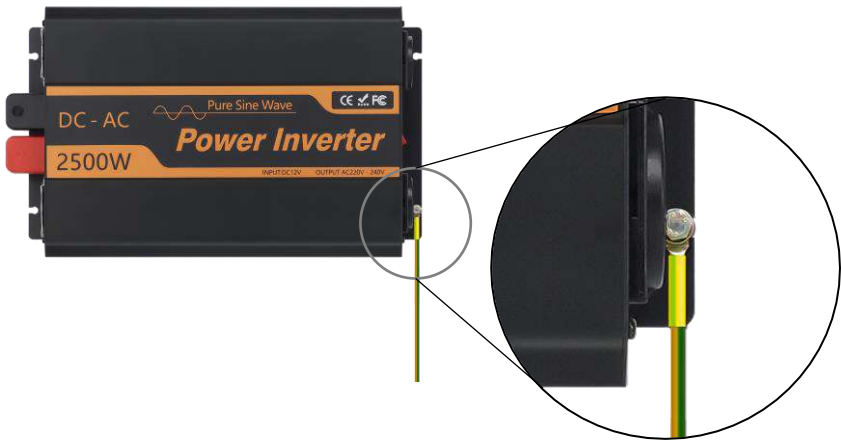

#### NOTE

- Ensure the inverter enclosure is grounded first. If the device enclosure becomes live due to a fault, grounding will quickly direct the current to the ground, preventing electric shock from contact with the live enclosure.

### 4.3 Battery Connection

Connect the positive and negative terminals of the battery as shown in the diagram below. Be sure to install breakers that meet the required specifications on the battery lines.

1. First, connect the positive and negative battery cables to the battery terminal block.



2. Then install the terminal cover.

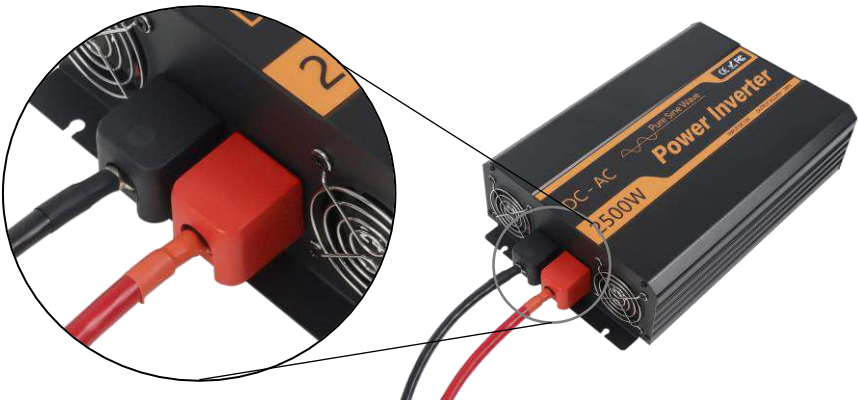

#### NOTE

- The POW-HV-EU series inverter's battery lines come with spare replacement fuses. Use them as needed.
- After completing the connection, carefully check if the positive and negative cables are connected correctly and if the terminals are securely fastened.

## 4.4 Remote Control Panel Connection

Connect the remote control panel to the inverter using the dedicated communication cable provided in the package.

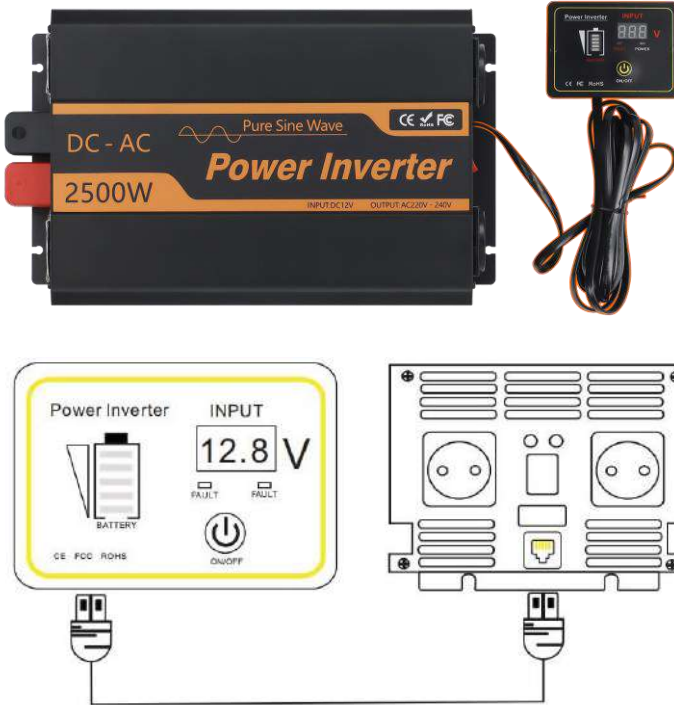

## 5 Operation

### 5.1 Starting the Inverter

After closing the battery circuit breaker, start the inverter using the power switch on the inverter body or the power switch on the remote control panel.

#### NOTE

- The switch on the remote control panel and the switch on the inverter body are independent. If you start the inverter using the power switch on the inverter, you must use this switch to turn off the inverter; you cannot use the remote control panel to do so. Similarly, if you start the inverter using the remote control panel, you must use the remote control panel to turn it off.

### 5.2 Connecting Loads

1. After the inverter starts normally, connect the plugs of the loads.
2. Ensure all cables are properly installed and securely connected.



#### DANGER

- Before connecting the AC output, ensure all loads are in the off state. Do not operate while the system is live.
- Check that the cables used meet the requirements. Thin or poor-quality cables pose serious safety hazards.

## 5.3 Remote Control Panel Overview

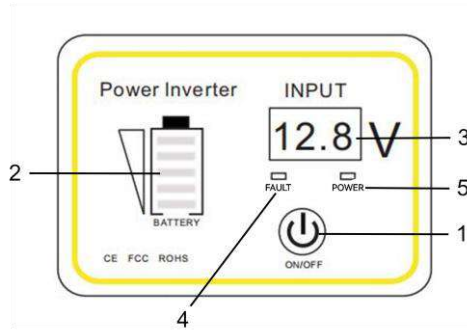

No.	Description	
1	Power Switch	Used to turn the inverter power on or off.
2	Battery Level Indicator	Displays the battery charge level.
3	Input Voltage	Displays the battery voltage.
4	Fault Indicator	Indicates that the inverter has encountered a fault.
5	Operation Indicator	Indicates that the power is on and the inverter is running.

### 5.3.1 Functions of the Remote Control Panel

- Remote control of the inverter's power on/off status.
- View battery voltage through the LCD display.
- Display battery capacity.
- Display inverter status.

#### NOTE

- The switch on the remote control panel and the switch on the inverter body are independent. If you start the inverter using the power switch on the inverter, you must use this switch to turn off the inverter; you cannot use the remote control panel to do so. Similarly, if you start the inverter using the remote control panel, you must use the remote control panel to turn it off.

## 6 Protection Functions

Protection Functions	Description
Overload Protection	When the load exceeds 125%, the inverter will send an alarm and stop working after 20 seconds. Once the load is reduced to within the supported range, the inverter will resume working. If the load is excessively high, the inverter will immediately stop working, with the red fault indicator flashing and the buzzer sounding an alarm. The device will then automatically restart, but if the overload condition persists during the restart, the load must be turned off to restore normal operation.
Short Circuit Protection	The inverter will automatically shut down in the event of a short circuit.
Over-temperature Protection	When the internal temperature of the inverter reaches 80°C, the red fault indicator will light up. The inverter will stop working, and once the temperature drops to an acceptable level (below 75°C), the inverter will automatically resume working.
Low Voltage Protection	When the battery voltage falls below the low voltage warning level ( $10.5 \pm 0.3V$ ), the inverter will issue an alarm with a beeping sound. If the battery voltage continues to drop to the low voltage cut-off level ( $9.5 \pm 0.2V$ ), the inverter will issue a beeping alarm, illuminate the red fault LED indicator, and stop working. When the battery voltage rises above the low voltage recovery level ( $11.8 \pm 0.3V$ ), the inverter will automatically resume operation.
Over-voltage Protection	When the input voltage exceeds the high voltage protection level ( $15.5 \pm 0.5V$ ), the inverter will stop working and illuminate the red fault LED indicator. When the input voltage drops below the high voltage recovery level ( $15.7 \pm 0.3V$ ), the inverter will automatically resume operation.
Reverse Connection Protection	In the event of reverse connection, the inverter's fuse will blow. In this case, please turn off the power, disconnect the power source, and replace the fuse (a spare fuse is provided with the inverter) to restore normal operation. Reverse connection is strictly prohibited.

## 7 Troubleshooting

Problem	Possible Causes	Solutions
Inverter has no output	Overload	Reduce the connected load; ensure total load is within the inverter's rated output power.
Overheating protection activated	Obstruction of device cooling	Check for obstructed airflow around the device; ensure sufficient ventilation.
	High ambient temperature	In high ambient temperatures, reduce overall power consumption.
Fuse blown	Short circuit in the circuit	Replace the fuse with the same model (spare fuse included in the inverter package).
Under-voltage protection triggered	Battery under-voltage	Recharge the battery.



## 8 System Maintenance

1. To maintain optimal long-term performance, it is recommended to perform the following checks twice a year:
2. Ensure airflow around the all-in-one machine is not obstructed; clean any dirt or debris from the heat sink.
3. Inspect all exposed wires for insulation damage due to sun exposure, friction with surrounding objects, dryness, insect or rodent damage, etc. Repair or replace wires as necessary.
4. Verify that indicators and displays are consistent with device operation; take corrective action for any faults or error displays.
5. Check all terminal connections for corrosion, insulation damage, signs of high temperature, or burning/discoloration marks; tighten terminal screws.
6. Check for dirt, nesting insects, and corrosion; clean as required.

### 8.1 Damage Disclaimer:

The company assumes no responsibility for damage caused under the following conditions:

1. Improper use or use in unsuitable locations.
2. Damage caused by operating environment temperatures exceeding specified limits.
3. Unauthorized disassembly and repair of the all-in-one machine.
4. Damage due to force majeure: damage occurring during transport or unloading of the all-in-one machine.

### 8.2 Non-Warranty Conditions:

The following conditions are not covered by warranty:

1. User-configured batteries.
2. Equipment damage caused by improper operation according to user guidelines.
3. Machine damage due to natural disasters such as fire or flood.
4. Products beyond the warranty period, subject to paid repair services.

## 9 Specifications

Model	POW-HV2.5K-12V-EU	POW-HV3.5K-12V-EU
System Voltage (Input Voltage)	12VDC	
Output Voltage	220VAC±10%	
Output Waveform	Pure Sine Wave	
Output Frequency	50Hz	
USB Output	5V/2.4A	
No-load Power Consumption	< 1A	< 1.5A
Surge Capacity	≤5000W	≤7000W
Efficiency	≥85%	
Low Voltage Warning Level	10.5±0.3V	
Low Voltage Cut-off Level	9.5±0.2V	
High Voltage Protection Level	15.5±0.5V	
Low Voltage Recovery Level	11.8±0.3V	
High Voltage Recovery Level	15.7±0.3V	
Overload Protection	120~125%	
Overtemperature Protection	> 80°C	
Operating Temperature Range	-10°C~+45°C	
Altitude	≤3000m	
Dimension(LxWxH)	352x207x85mm	390x207x85mm
Net weight	4.18kg	5.38kg



# POWMr

SHENZHEN HEHEJIN INDUSTRIAL CO.,LTD

---

Tel/Fax: +86 755-28219903

Email: [support@powmr.com](mailto:support@powmr.com)

Web: [www.powmr.com](http://www.powmr.com)

Add: Henggang Street, Longgang District, Shenzhen, Guangdong, China