

35mm single glass-182-72pcs module frame

Technical Specifications:

1. Dimension tolerance not signed in this drawing according to $\pm 0.5\text{mm}$.
2. The angle of frame cutting is less than 0.3° during the frame further processing.
3. Frame should be in accordance with company standards, technical requirements should be consistent with 《The technical agreement for aluminum frame》.
4. The profile have not serious scratch, not notch in the edge, the cutting side is uniform and the thin film can not be avulsed.
5. Removing the null, rotor, aluminum scrap, have not obvious angle.
6. After the frame is solidified, the long side of the component is subjected to 60N vertical force without any looseness.
7. Please pay attention to the orientation of corner brace during the loading (round-bevel angle is outside and round-straight angle is inside). Scour after the loaded the corner brace and the phenomena of sway must be diminished. To the frame and corner brace, even suspense the heavy object reach to 20kg for 300s, the distance between must be controlled less than 0.3mm. Ensure install normally, no loosening or crowding
8. XX is the suppliers' acronym, font size is $3 \times 2\text{mm}$, depth 0.15mm. Position: The center of the four riveting points, at least there is one sign.
9. Material of 6005 T6 requires tensile strength $R_m \geq 240\text{MPa}$, yield strength $R_p0.2 \geq 200\text{MPa}$, elongation $\geq 6\%$.

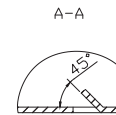
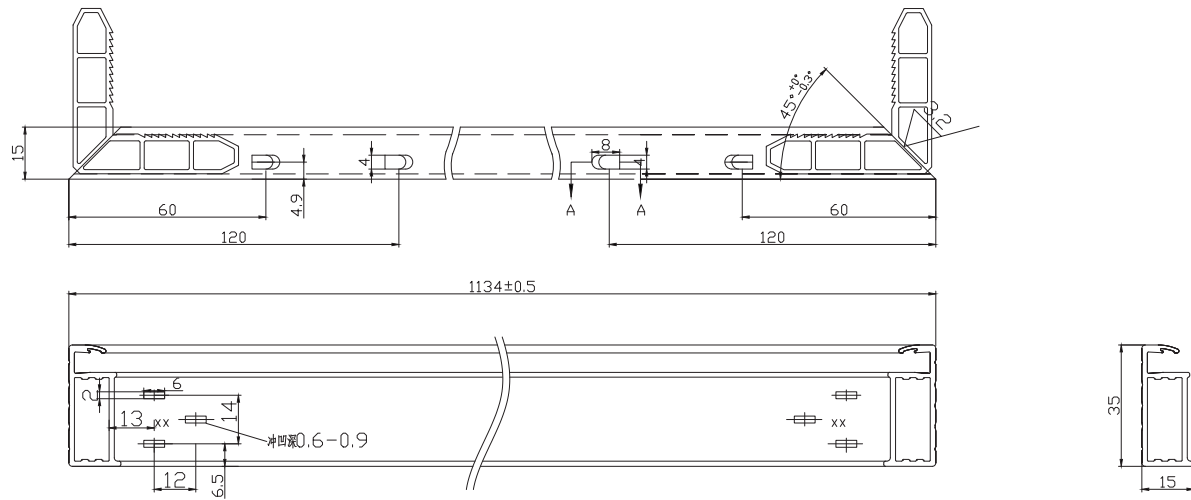

Technical Specifications:

1. Dimension tolerance not signed in this drawing according to $\pm 0.5\text{mm}$.
2. The angle of frame cutting is less than 0.3° during the frame further processing.
3. Frame should be in accordance with company standards, technical requirements should be consistent with 《The technical agreement for aluminum frame》.
4. The profile have not serious scratch, not notch in the edge, the cutting side is uniform and the thin film can not be avulsed.
5. Removing the null, rotor, aluminum scrap, have not obvious angle.
6. After the frame is solidified, the long side of the component is subjected to 60N vertical force without any looseness.
7. Please pay attention to the orientation of corner brace during the loading (round-bevel angle is outside and round-straight angle is inside). Scour after the loaded the corner brace and the phenomena of sway must be diminished. To the frame and corner brace, even suspense the heavy object reach to 20kg for 300s, the distance between must be controlled less than 0.3mm. Ensure install normally, no loosening or crowding
8. XX is the suppliers' acronym, font size is $3 \times 2\text{mm}$, depth 0.15mm. Position: The center of the four riveting points, at least there is one sign.
9. Material of 6005 T6 requires tensile strength $R_m \geq 240\text{MPa}$, yield strength $R_p0.2 \geq 200\text{MPa}$, elongation $\geq 6\%$.

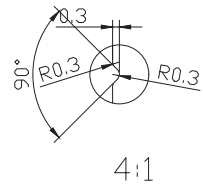
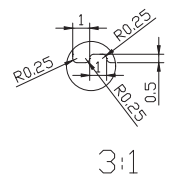
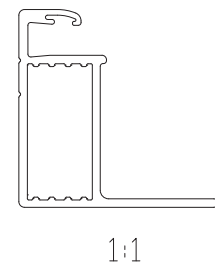
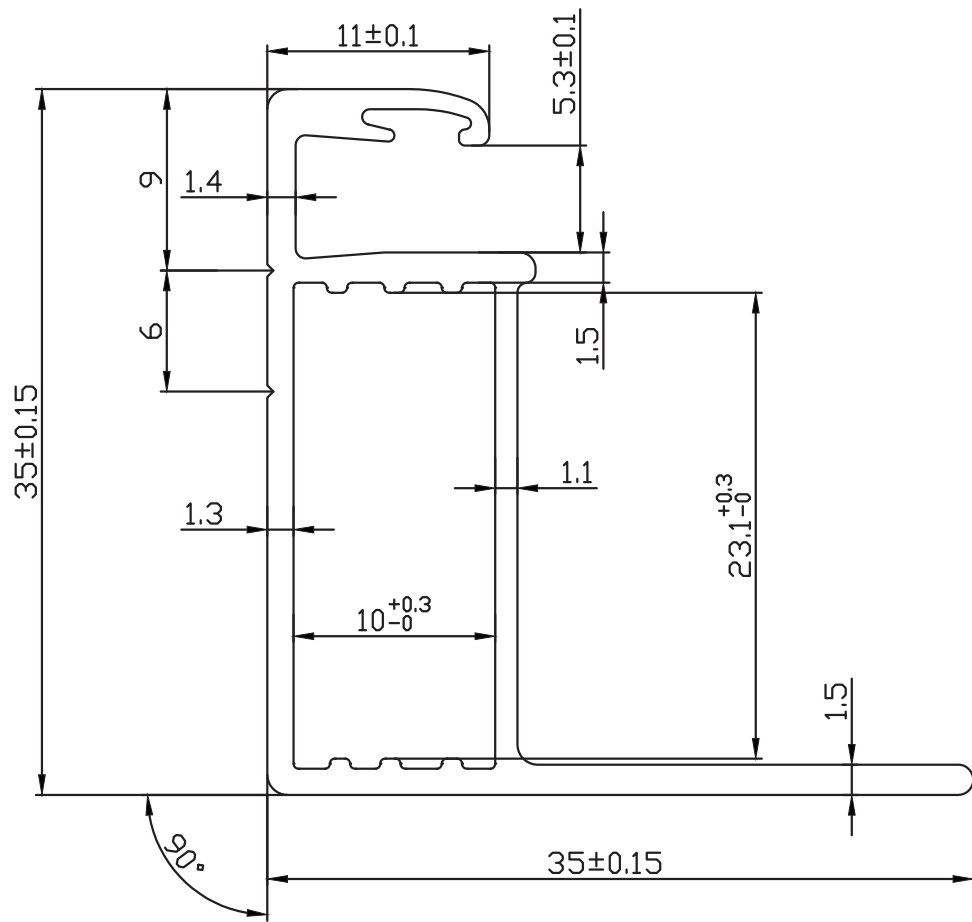

- Technical Specifications:
- 1.The rounded corner is 0.3(radius) not marked in the drawing and the ornamental surface divided by two line.
 - 2.Frame should be in accordance with company standards , technical requirements should be consistent with 《The technical agreement for aluminum frame》 .
 - 3.The standard of implement in terms of GB5237-2008 superior level.
 - 4.Shape and position tolerance not signed in this drawing according to GB/T1184-1996-k.
 - 5.Dimension tolerance not signed in this drawing according to GB/T1804-2000-m.
 - 6.The Webster Hardness of aluminum profile than or equal to 15.
 - 7.Cross-sectional area:157.9474mm² ,theoretical weight per meter:0.4265kg/m,Aluminum density:2700kg/m³ .



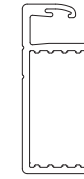
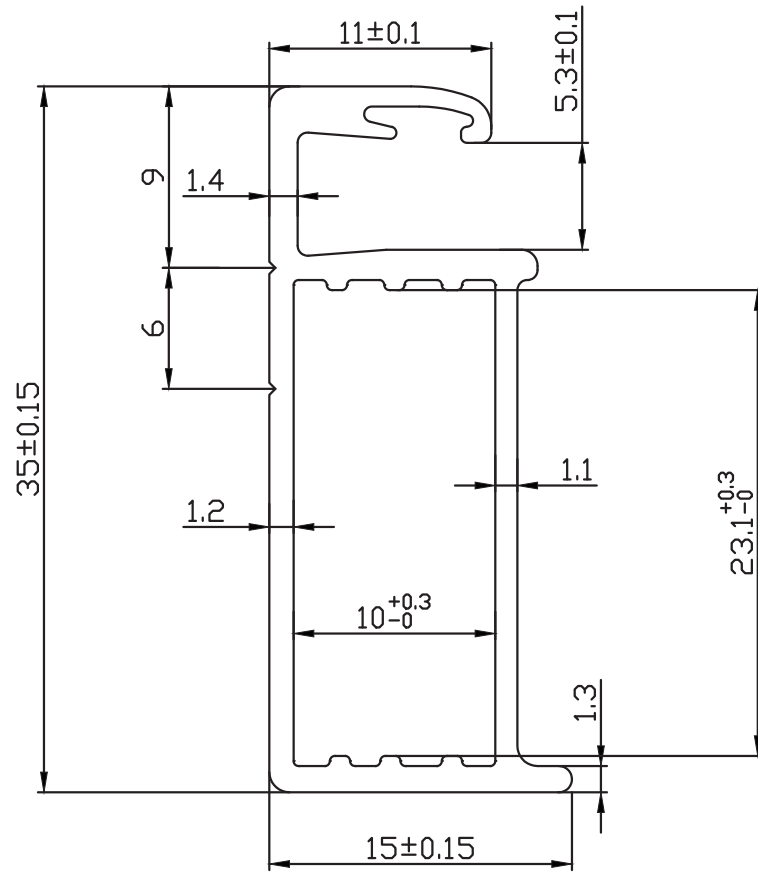

1:1

Technical Specifications:

1. The rounded corner is 0.3(radius) not marked in the drawing and the ornamental surface divided by two line.
2. Frame should be in accordance with company standards , technical requirements should be consistent with 《The technical agreement for aluminum frame》 .
3. The standard of implement in terms of GB5237-2008 superior level.
4. Shape and position tolerance not signed in this drawing according to GB/T1184-1996-k.
5. Dimension tolerance not signed in this drawing according to GB/T1804-2000-m.
6. The Webster Hardness of aluminum profile than or equal to 15.
7. Cross-sectional area:124.8584mm² ,theoretical weight per meter:0.337kg/m, Aluminum density:2700kg/m³.

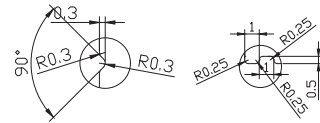

3:1

4:1



Drawing No.

GS-DWG-FR-013-A2

4/5

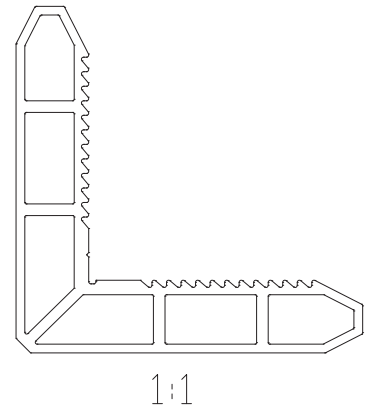
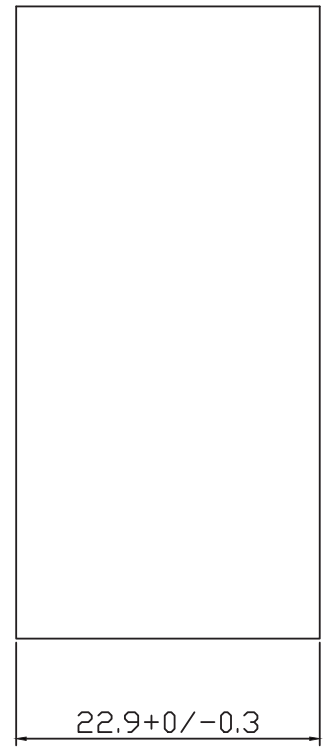
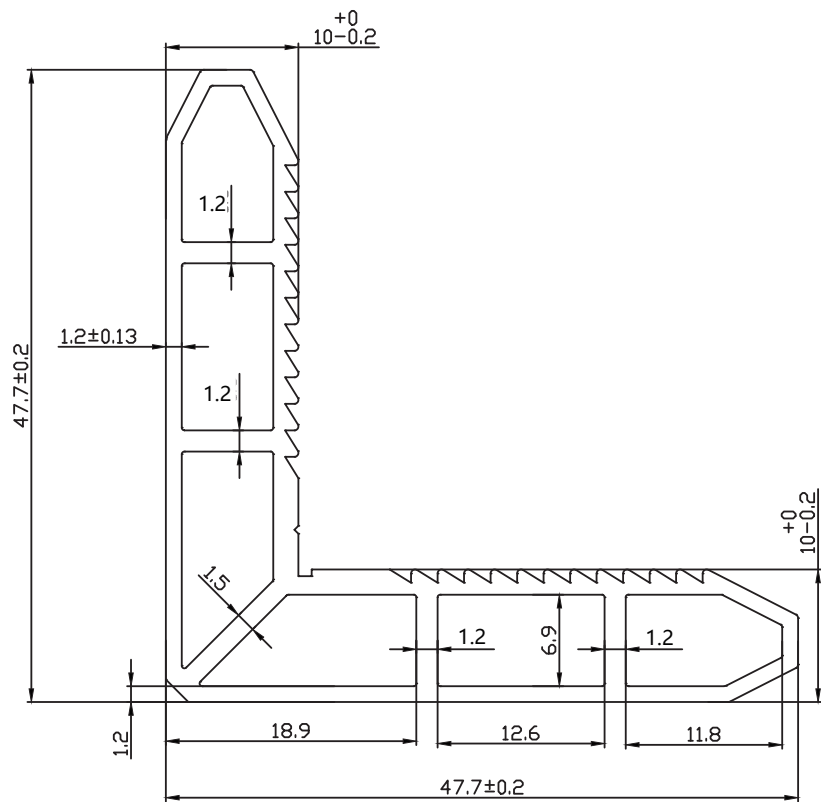

- Technical Specifications:**
- 1.The rounded corner is 0.3(radius) not marked in the drawing and the ornamental surface divided by five line.
 - 2.Frame should be in accordance with company standards , technical requirements should be consistent with 《The technical agreement for aluminum frame》 .
 - 3.The standard of implement in terms of GB5237-2008 superior level.
 - 4.Shape and position tolerance not signed in this drawing according to GB/T1184-1996-k.
 - 5.Dimension tolerance not signed in this drawing according to GB/T1804-2000-m.
 - 6.The Webster Hardness of aluminum profile than or equal to 15.
 - 7.Cross-sectional area:286.98mm² ,theoretical weight per meter:0.775kg/m,Aluminum density:2700kg/m³ .

