

Specifications

Nominal Voltage		12 V
Capacity (25°C)	10HR(10.8V)	105 Ah
	5HR(10.5V)	92Ah
	1HR(9.60V)	65Ah
Dimension	Length	395 ± 2mm (15.55inch)
	Width	110 ± 2mm (4.33inch)
	Height	286 ± 2mm (11.26inch)
	Total Height	286 ± 2mm (11.26inch)
Approx. Weight		32kg (70.6lbs) ± 4%
Terminal type		T9
Internal resistance (Fully charged, 25°C)		Approx. 5.5m Ω
Capacity affected by temperature (10HR)	40°C	102%
	25°C	100%
	0°C	85%
	-15°C	65%
Self-discharge (25°C)	3 month	Remaining Capacity: 91%
	6 month	Remaining Capacity: 82%
	12 month	Remaining Capacity: 65%
Nominal operating temperature		25°C ± 3°C (77°F ± 5°F)
Operating temperature range	Discharge	-15°C ~ 50°C (5°F ~ 122°F)
	Charge	-10°C ~ 50°C (14°F ~ 122°F)
	Storage	-20°C ~ 50°C (-4°F ~ 122°F)
Float charging voltage(25°C)		13.50 to 13.80V Temperature compensation: -18mV/°C
Cyclic charging voltage(25°C)		14.50 to 14.90V Temperature compensation: -30mV/°C
Maximum charging current		31.5A
Terminal material		Copper
Maximum discharge current		800A(5 sec.)
Designed floating life(20°C)		15 years

- ◆ Absorbent glass mat technology;
- ◆ Recognized by UL & CE;
- ◆ ABS container.

Constant Current Discharge Characteristics (A, 25°C)

F.V/TIME	15min	30min	60min	2h	3h	4h	5h	6h	8h	10h	20h
9.60V	170	103	65.1	38.4	26.8	22.0	18.7	16.4	12.9	10.7	5.61
9.90V	166	101	64.1	38.1	26.6	21.8	18.6	16.3	12.8	10.7	5.60
10.2V	160	97.8	62.5	37.8	26.4	21.7	18.5	16.2	12.7	10.6	5.58
10.5V	154	95.4	61.3	37.2	26.3	21.5	18.4	16.1	12.6	10.6	5.55
10.8V	146	91.9	59.4	36.3	25.5	20.9	17.8	15.6	12.2	10.5	5.51

Constant Power Discharge Characteristics (Watt, 25°C)

F.V/TIME	15min	30min	60min	2h	3h	4h	5h	6h	8h	10h	20h
9.60V	1864	1155	742	444	315	258	222	194	153	128	67.3
9.90V	1819	1131	731	442	313	257	220	193	152	127	67.2
10.2V	1752	1097	712	438	311	255	219	191	151	127	67.0
10.5V	1693	1070	698	431	309	253	217	190	150	126	66.6
10.8V	1603	1031	677	420	299	246	211	184	145	125	66.2

Note: The above characteristics data can be obtained within three charge/discharge cycles.



Dimensions

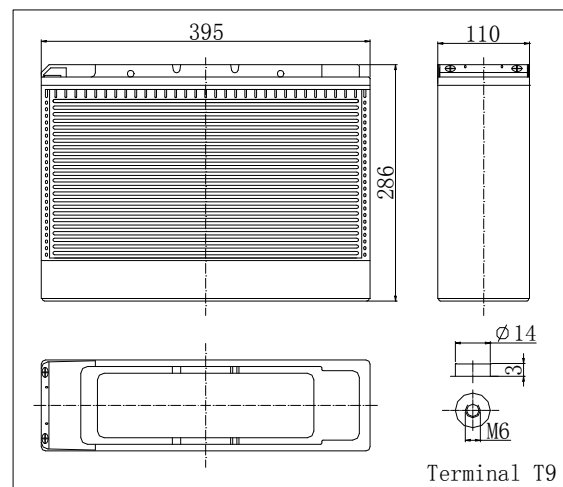

Terminal

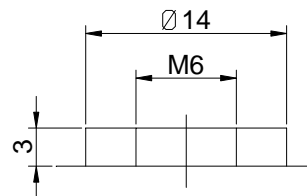

Terminal T9

Discharge Characteristics(25°C)

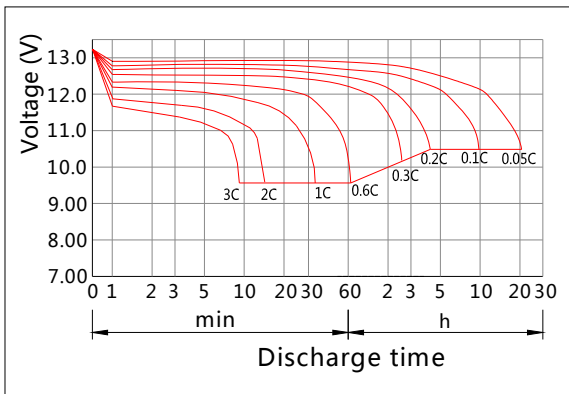

Charging Characteristics(25°C)

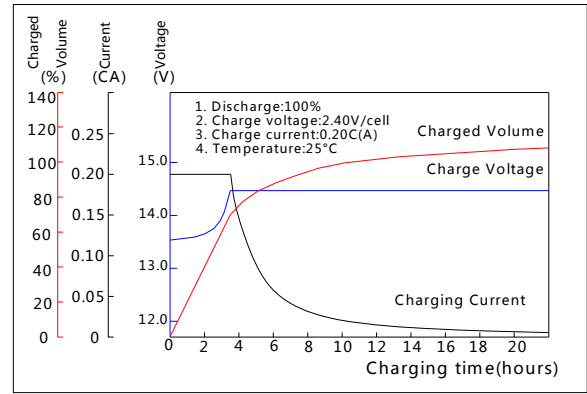

Effect of Temperature on Capacity

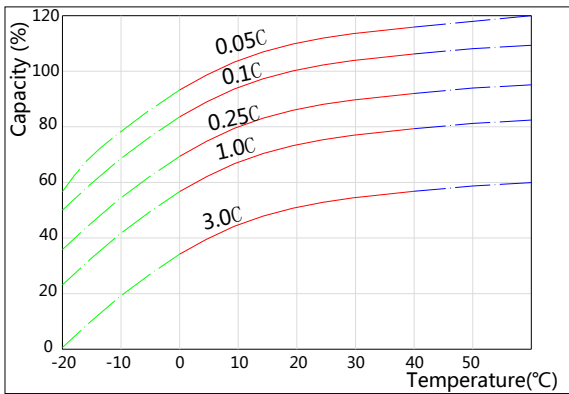

Self-discharge Characteristics

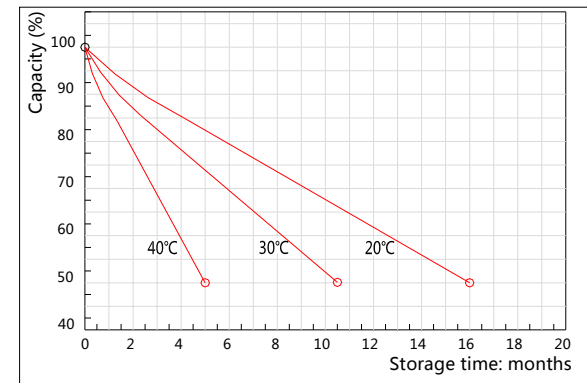

The Relationship for Open Circuit Voltage and Residual Capacity (25°C)

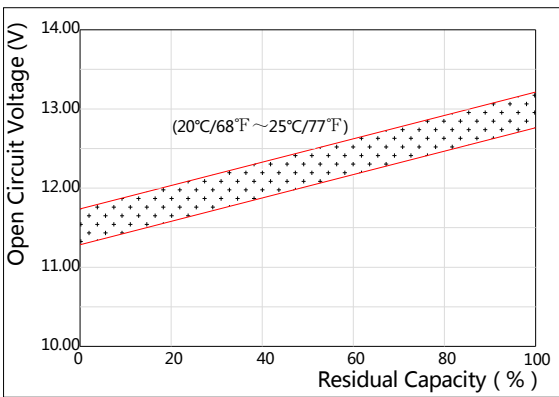

The Relationship for Charging Voltage and Temperature

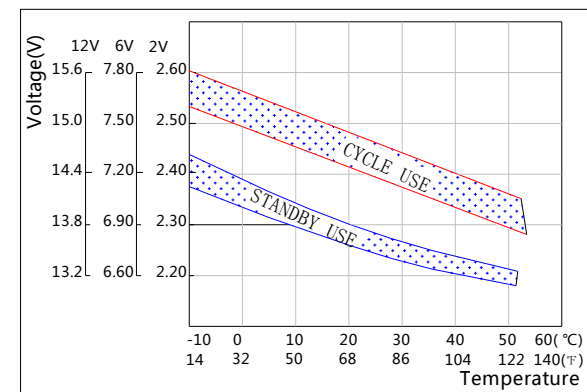

Floating Life on Temperature

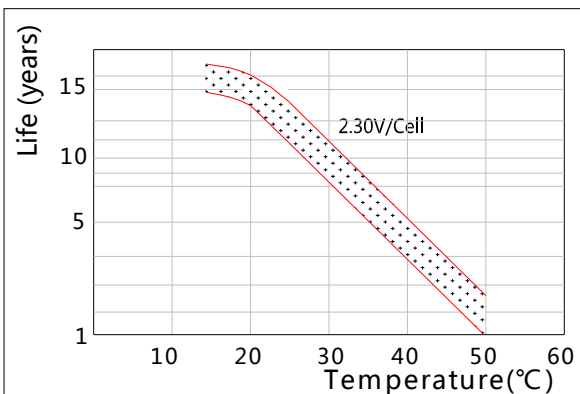

Cycle Life on D.O.D(25°C)

