

Mid Clamp Series

MG-MC-N-F Mid Clamp Kit

30/32/35/40/45/50 mm (the thickness of solar panel)

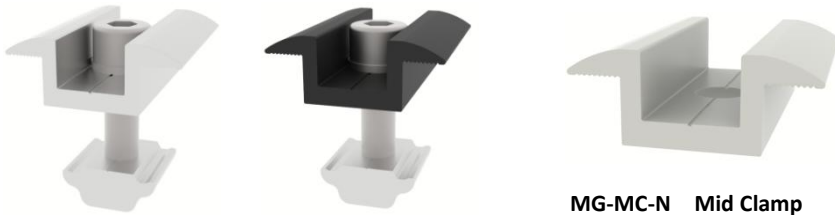

MG-MC-N Mid Clamp

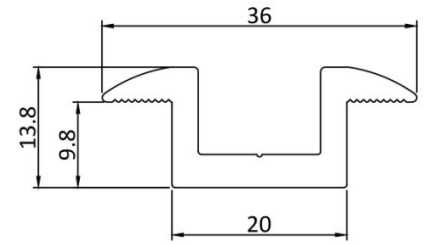

MG-AGM-MC-F Mid Clamp Kit

25/30/35/40/45/46/50 mm



MG-AGM-MC Mid Clamp

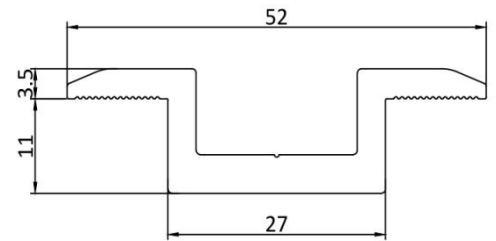

MG-MC-C-F Mid Clamp Kit

30/32/35/40/45/50 mm

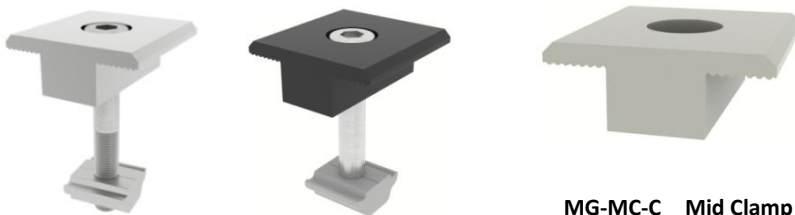

MG-MC-C Mid Clamp

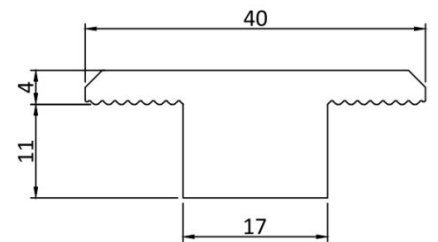

MG-RV-C-MC-F Mid Clamp Kit



MG-RV-C-MC Mid Clamp

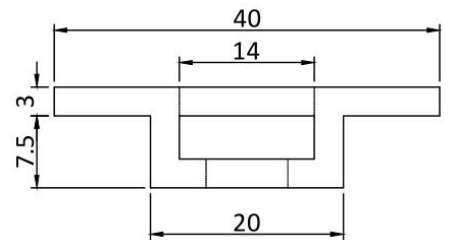

MG-AMC-K Adjustable Mid Clamp Kit

Adjustable Range: 30mm~45 mm



MG-AMC-C Adjustable Mid Clamp

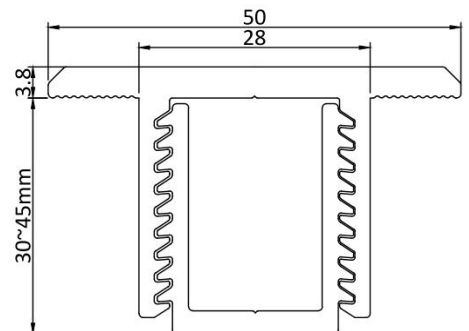

Mid Clamp and End Clamp Series

MG-MC-K-F Mid Clamp Kit

F=30/35/40 mm

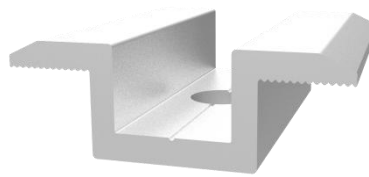

MG-MC-K Mid Clamp

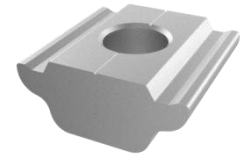

MG-CC-CN-01 Channel Nut 01#

MG-MC-WS-F30/35 Mid Clamp with Spring Kit

MG-MC-WS-F35/40

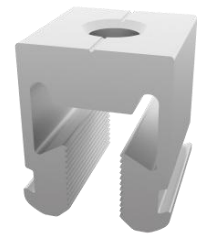
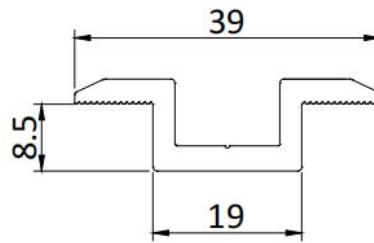
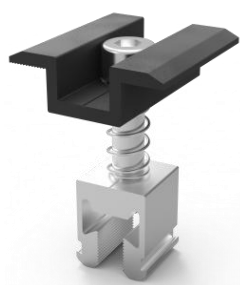
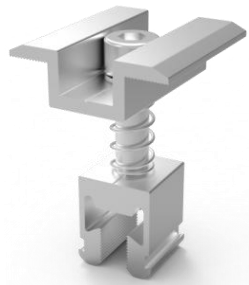

MG-CC-CN-02 Channel Nut 02#

MG-EC-WS-F End Clamp with Spring Kit

F=30/35/40 mm

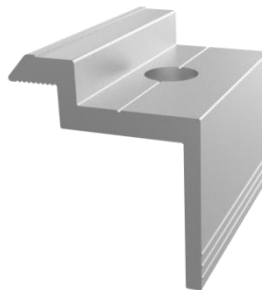
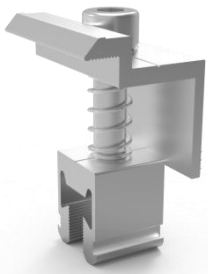

MG-EC-W-F

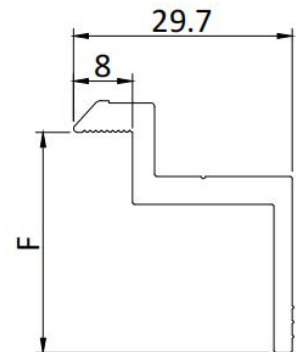

Mid Clamp and End Clamp on Rails

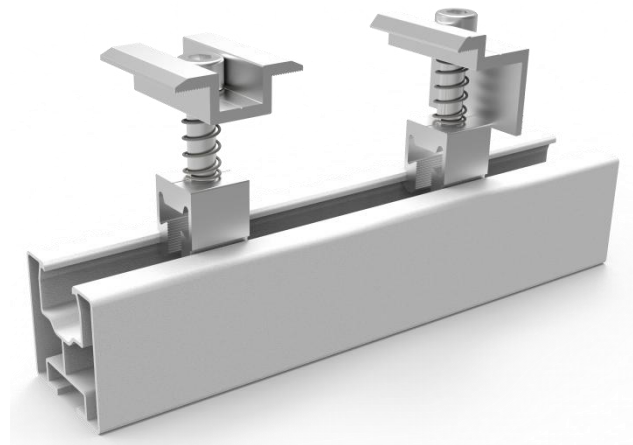
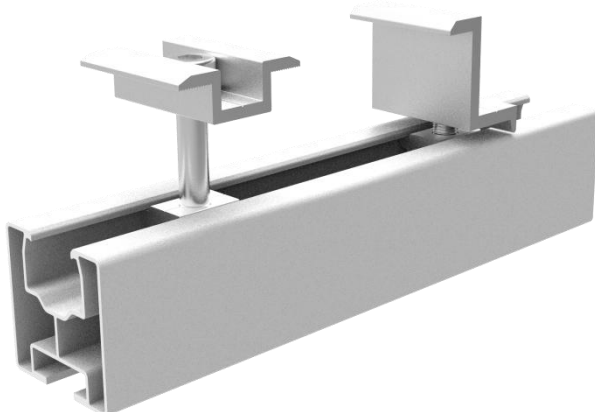

Assembled Diagram

End Clamp Series

MG-EC-K-F End Clamp Kit
F=30/35/40/45/50 mm

MG-EC-C-F30/35/40/45/50
End Clamp

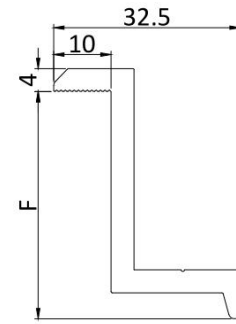
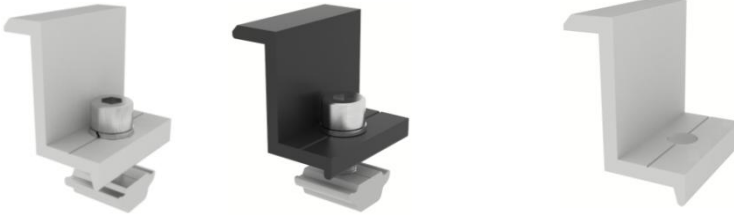

MG-AGM-EC-K-F End Clamp Kit
F=25/30/32/35/40/45/46/50 mm

MG-AGM-EC-C-F25/30/32/35/40/45/50
End Clamp

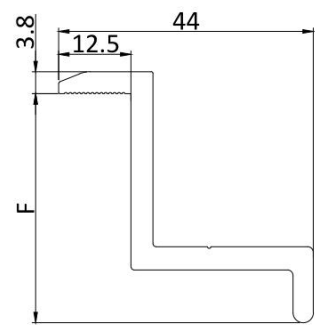
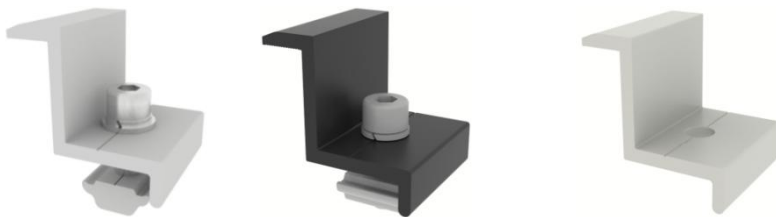

MG-AEC-K-N Adjustable End Clamp Kit

MG-AEC-C-N

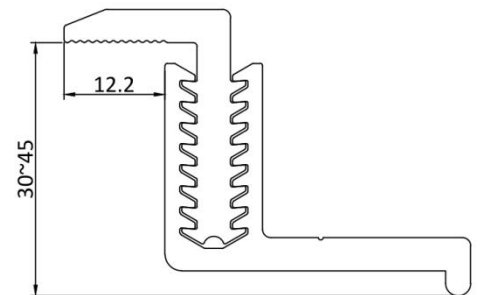
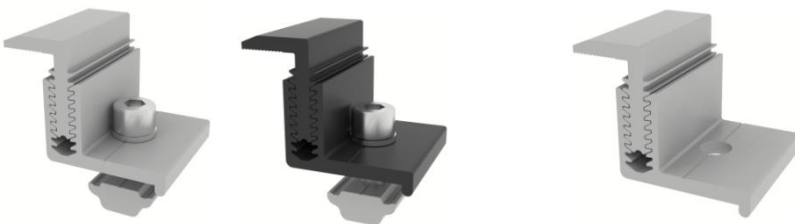

MG-TF-MCK-L80 Thin Film Mid Clamp Kit, 80 mm
MG-TF-MCK-L120 Thin Film Mid Clamp Kit, 120 mm

MG-TF-ECK-L80 Thin Film End Clamp Kit, 80 mm
MG-TF-ECK-L120 Thin Film End Clamp Kit, 120 mm

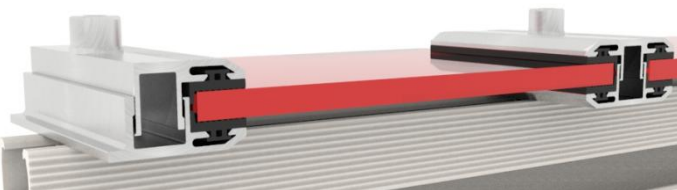
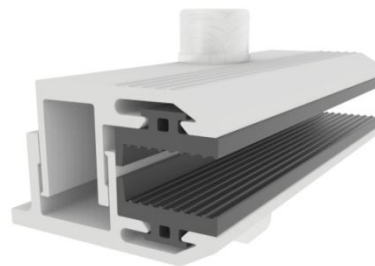
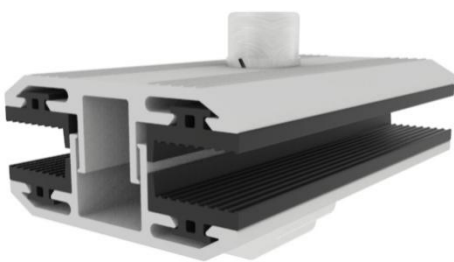

- ◆ Suitable for 5~9mm thickness solar panel;
- ◆ 80mm and 120mm length are common use;
- ◆ 150mm and 200mm length are also available;
- ◆ Customized can be accepted;