



Now supports PylonTech LITHIUM Batteries!

MPI 5.5K



MPI 5K



MPI 10K (3-Phase)



MPI HYBRID SOLAR INVERTER SERIES

GRID-TIED + BATTERY BACKUP

MPI Hybrid Series

These hybrid solar inverters combine the features of both grid-tied and off grid operations, and allow users to operate in 3 main modes:

- Grid-Tied (Feedback)
- Off Grid
- Grid-Tied with Battery Backup

Available in 5KW, 5.5KW (single phase) and 10kw (3 phase), these hybrid systems offer an excellent all-in-one solution of off-grid inverter + grid-tie inverter + battery charger. Able to accept PV input voltage up to 900V (5K, 10K only) with MPPT functionality, the Hybrid family can support up to max PV array sizes of up to 14.85KW. This enables users great flexibility in running load as well as feeding extra solar power back to grid. When grid fails, these systems will switch to battery source like an off-grid inverter and keep load backed up. The bundled monitoring software, SolarPower, offers powerful features that allow users total control and access to a wide variety of operations to meet different application demand. Hybrid models are fully compliant to and certified in VDE (Germany) and CE standards (AS4777 available on 5.5K and 10K only).

**Optional accessories such as MODBUS card, MODBUS server, and Energy Meter are available upon request



New Features



These new features are now available on selective Hybrid models:



HIGH CHARGING

Max battery charging current now up to **200A!** (10K)

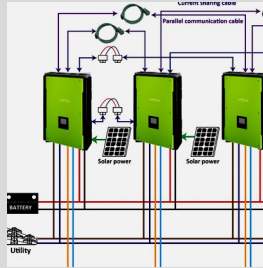

STACKABLE

Supports parallel operation up to **6 units max!** (4K,5K, 10K only)



EMS PORT

this useful port is for emergency light load, 230V/5A (4K, 5K only)



DUAL AC INPUT

grid + generator. Genset starter dry contact available (4K, 5K only)

MPI 5K SINGLE VS PARALLEL CONCEPT

*MODBUS card, Energy Meter, and Web-box are optional accessories.

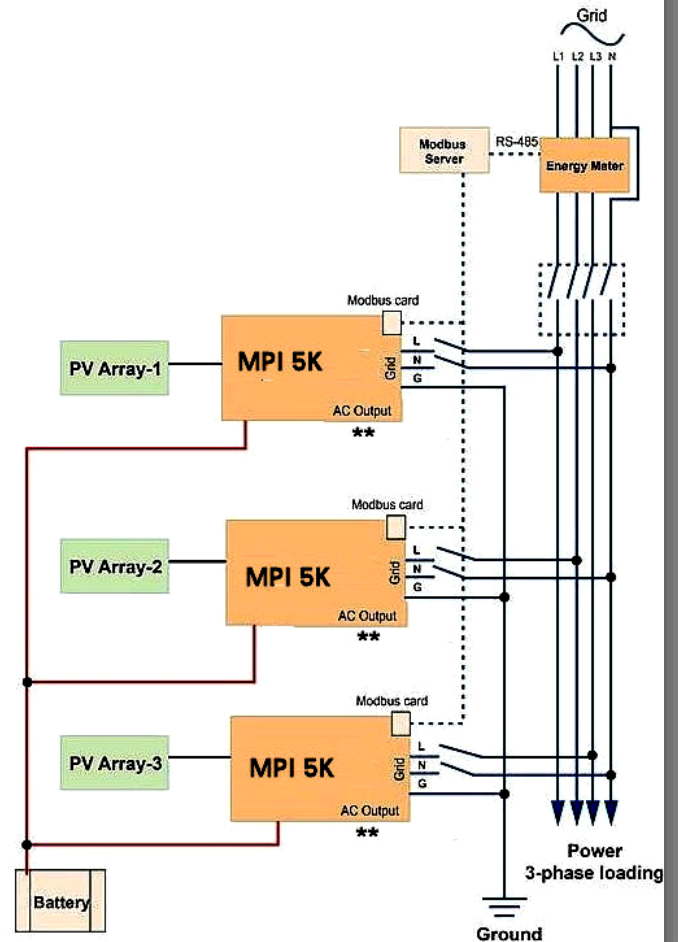
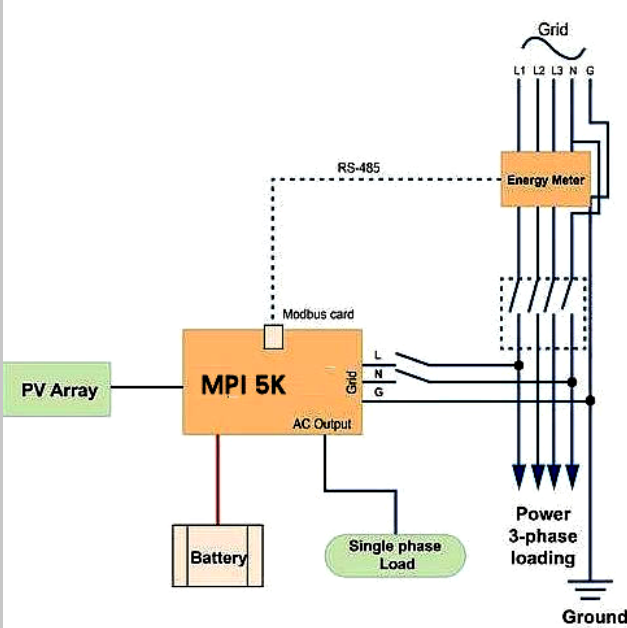

**** In a parallel output setup, max power supported via AC OUTPUT is up to 30KW (6 units max in parallel). Parallel setup will void the use of energy meter.**

*Product specifications are subject to change without prior notice. MPP Solar is a registered trademark of MPP Solar Inc.

Operation Modes



GRID-TIE + BATTERY BACKUP

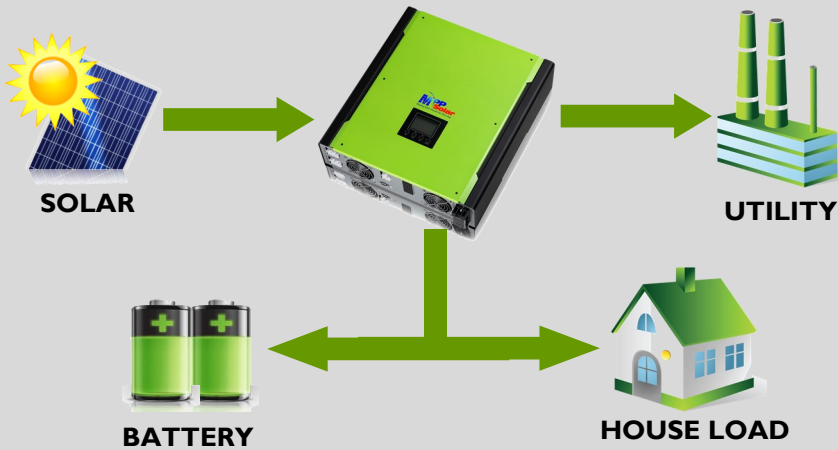

In this operation mode, users can program unit to

- Feedback PV power to utility
- Provide PV power to load
- Charge battery by PV

Different priority settings are available in this mode.

Charging source may be selected from PV and grid as default, PV only, or none (when charging not intended). All programming conditions can be done in the CD-bundled software.

GRID-TIE ONLY



In this operation mode, the inverter will only behave like a pure grid-tie inverter where it only feeds back electricity to grid from PV source.

There is no priority setting available when this mode is selected.

OFF-GRID ONLY

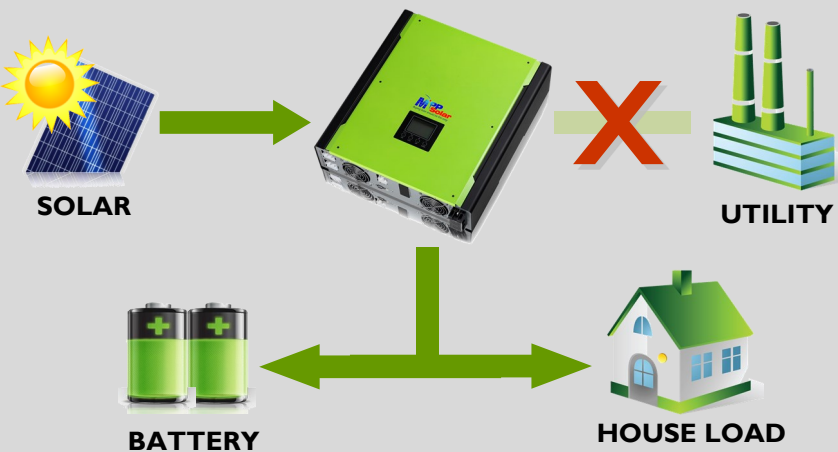

In this operation mode, grid feedback to utility is disabled. Users can only program unit to:

- Provide PV power to load
- Charge battery by PV

Different priority settings are also available, and grid relay may be connected to inverter to provide support when load > 3kw. Charging source may be selected from PV and grid, PV only, or none (charging not intended). All programming can be done in the CD-bundled software.

*Product specifications are subject to change without prior notice. MPP Solar is a registered trademark of MPP Solar Inc.

Specifications



MPI HYBRID SERIES	5K	5.5K	10K
MAIN SPECS			
Continuous Output	5,000W	5,500W	10,000W
Parallel-Ready	Yes, up to 6 units	No	Yes, up to 6 units
PV INPUT RATING (GRID-TIED)			
Max PV Input Power	10,000W	6,500W	14,850W
Max PV Input Voltage	900Vdc	500Vdc	900Vdc
Start-up / Initial Feeding Voltage	250 / 300 Vdc	116 / 150Vdc	320 / 350 Vdc
PV MPPT Range	250 - 850 Vdc	120 - 450Vdc	350 - 850 Vdc
Max PV Input Current	10A x 2	13A x 2	18A x 2
MPPT Tracker	2	2	2
Max DC/AC Conversion Efficiency	>96%		
AC INPUT SPECS			
Start-up / Auto Restart Voltage	120 - 140Vac / 180Vac (per phase)		
Input Voltage Range	170 - 280Vac (per phase)		
Nominal Frequency	50 / 60 Hz		
Max AC Input Current	40A	40A	40A
AC OUTPUT SPECS			
Nominal AC Output Voltage	208/220/230/240Vac, Single Phase	400Vac, 3-Phase	
Output Voltage Range	184 - 265Vac	184 - 265Vac (P-N) / 318 - 460Vac (P-P)	
Output Frequency (GRID-TIE)	47.5 - 51.5Hz / 59.3 - 60.5 Hz		
Output Frequency (OFF-GRID)	50 / 60Hz, auto-sensing		
Output Waveform	Pure Sine Wave		
Max Output Power (via grid relay)	7,000W	6,500W	16,000W
Max Output Power (battery)	5,000W	5,500W	10,000W
Max Efficiency	>93%		>91%
BATTERY CHARGER			
Nominal DC Voltage	48Vdc		
Max Charging Current	100A	60A	200A
ENVIRONMENTAL / COMMUNICATION			
Communication Port	RS232 / USB, Intelligent Slot (card)		
Certifications	EN62109-1, EN62109-2, EN62040-1 / CE, VDE4105, VDE0126-1-1, AS4777/3100 (5.5K, 10K only)		
Operating Temp.	-10 - 50°C	0 - 40°C	-10 - 50°C
Operating Humidity	0 - 90% RH (No condensing)		
Dimension	600*460*200mm	450*445*110mm	622*500*167mm
Net Weight	29Kg	16Kg	45Kg

*Product specifications are subject to change without prior notice. MPP Solar is a registered trademark of MPP Solar Inc.