

Important Safety Instructions

Please keep the user manual properly for future reference!



Warning: It is essential to read, understand, and adhere to all safety instructions provided in this document. Failure to comply with safety regulations may result in property damage or personal injury.

➤ Basic Guidelines

1. Before using the equipment, carefully review all relevant sections of the device, battery, and instruction manual for all guidance and warning signs.
2. Caution: To reduce the risk of injury, only charge deep-cycle lead-acid rechargeable batteries. Other types of batteries may rupture, causing personal harm.
3. This product does not contain user-serviceable parts. Do not disassemble the equipment. When maintenance or cleaning is required, take it to a qualified service center. Improper reassembly may pose risks of short-circuiting and fire. If any panel displays a malfunction, do not remove the front panel or operate the product. All operating procedures must be performed by trained professionals.
4. To reduce the risk of electric shock, disconnect all wiring before performing any maintenance and cleaning. Only turn off the main unit; this alone does not reduce the risk of electric shock.
5. Caution: Only qualified personnel should assemble the equipment with the battery.
6. Charging frozen batteries is prohibited.
7. Exercise extreme caution when using metal tools or placing them around the battery. Dropping tools can generate sparks or cause unpredictable risks such as short-circuiting the battery or other electronic components, potentially leading to explosions.
8. When disconnecting AC or DC terminals, strictly follow the installation steps as outlined in the instruction manual's installation section.
9. Before using this product, read the provided instructions to familiarize yourself with safety features and operating instructions. This product is designed and tested according to international standards. The equipment must be used exclusively for its intended purpose.

➤ **Installation**

1. Do not use this product in areas where there is a risk of gas or dust explosions. Prior to use, consult with the battery manufacturer's relevant literature to ascertain the compatibility of this product with the battery. Always adhere to the safety instructions provided by the battery manufacturer.
2. This is a safety-class product equipped with a protective grounding terminal. Continuous protective grounding must be provided by the AC input/output terminals.
3. Grounding Instructions: The inverter/charger should be connected to a permanent grounding wire system to ensure full compliance with local requirements and regulations for installing the inverter. When grounding protection may have been compromised, the product must be shut down to prevent accidental electric shock.
4. To ensure optimal operation of the inverter/charger, adhere to the required specifications and select appropriate cable sizes, which are crucial for the correct operation of the inverter/charger.
5. Before connecting to the mains power, ensure that the available power supply meets the parameters specified in the product manual.
6. Do not short-circuit the AC output and DC input. Do not connect the mains power when the DC output is short-circuited.
7. Ensure that the equipment is used in conditions compliant with standards. Do not operate the product in moist or dusty environments. Ensure there is sufficient clearance space around the product and check that ventilation holes are not blocked.
8. Ensure that the required system voltage does not exceed the capacity of the product.

➤ **Transportation and Storage**

1. Ensure that the power and battery cables are disconnected before storing or transporting the product.
2. If the equipment is not in its original packaging during transportation, any transport damage is not the responsibility of the manufacturer.
3. Store the product in a dry environment, with storage temperature between -20°C to 60°C .
4. Refer to the battery manufacturer's manual for information on battery transportation, storage, charging, recharging, and disposal.
5. Please follow these instructions diligently to ensure safe installation, operation, transportation, and storage of the product.

Table of Contents

Important Safety Instructions.....	1
1 Overview.....	3
1.1 Scope.....	3
1.2 Target Audience.....	3
1.3 Manual Usage.....	3
2 Product Overview.....	4
2.1 Features.....	4
2.2 System Basic Architecture.....	5
2.3 Product Appearance.....	6
3 Assembly.....	9
3.1 Unboxing and Inspection.....	9
3.2 Installation Tools.....	9
3.3 Equipment Installation.....	10
3.4 Wiring Preparation.....	10
4 Wiring.....	11
4.1 Cable Size and Circuit Breaker Specifications.....	11
4.2 AC Input & Output Connection.....	12
4.3 Battery Connection.....	15
4.4 Photovoltaic Connection.....	17
4.5 Final Assembly.....	18
4.6 Communication Connection.....	18
5 Operation.....	20
5.1 Starting the Inverter.....	20
5.2 Introduction to the Operation Panel.....	20
5.3 Display Panel Introduction.....	21
5.4 Interface Overview.....	23
5.5 Operating Modes.....	23
5.6 LCD Screen Settings.....	25
6 Troubleshooting.....	32

6.1 Alarms	32
6.2 Alarm Event	32
6.3 Errors.....	33
6.4 Troubleshooting	33
7 System Maintenance	34
8 Specifications	35
8.1 Table 1: Utility Mode Parameters.....	35
8.2 Table 2: Inverter Mode Parameters	36
8.3 Table 3: Charging Mode Parameters.....	37
8.4 Table 4: General Parameters.....	38

1 Overview

1.1 Scope

This user manual provides information, operation, and maintenance guidance for the POW-RELAB series grid-tied inverter-charger integrated machines. The POW-RELAB series products are grid-tied inverters developed by PowMr for solar energy storage systems, suitable for various residential or commercial applications.

1.2 Target Audience

This manual is intended for professional technical personnel involved in the installation, operation, and maintenance of lithium batteries, as well as end-users seeking technical information.

1.3 Manual Usage

1. Before using the product, carefully review this user manual and keep it stored in an easily accessible location.
2. All information in the user manual, including images and symbols, is the property of PowMr. Unauthorized use of any portion or all of the content is prohibited for individuals outside the company.
3. Considering the possibility of updates and revisions to the manual content, users are advised to use the accompanying manual as a reference. For the latest user manual, users can visit the official website or contact customer service.

2 Product Overview

2.1 Features

1. The POW-RELAB series grid-tied solar inverter-charger integrated machines from PowMr are suitable for most residential and commercial scenarios, ensuring higher output stability and reliability.
2. Flexible energy deployment is achieved through three operating modes, ensuring stable operation of loads while maximizing the utilization of solar clean energy. The energy-saving mode minimizes equipment self-consumption losses.
3. It combines pure sine wave inverter output with mains or generator bypass output functions, supporting solar charging and AC power charging. The output power and charging power can be prioritized according to actual application needs.
4. The bottom of the machine is equipped with battery circuit fuses to ensure circuit safety.
5. It features built-in multiple protection functions and precise alarm mechanisms, providing comprehensive protection for system safety and stability.
6. External communication is supported via RS232 or RS482. BMS communication is supported to effectively monitor battery operation, optimize battery pack operation efficiency, and extend the lifespan of the entire battery pack.

2.2 System Basic Architecture

The following illustration depicts the basic application of the inverter/charger, along with the additional equipment required to form a complete operational system:

- Engine or mains power
- Photovoltaic modules

Additional system architectures can be consulted with system integrators based on your requirements. This inverter can provide power to various electrical appliances in residential or office environments, including lamps, fans, refrigerators, air conditioners, and other motor-type appliances.

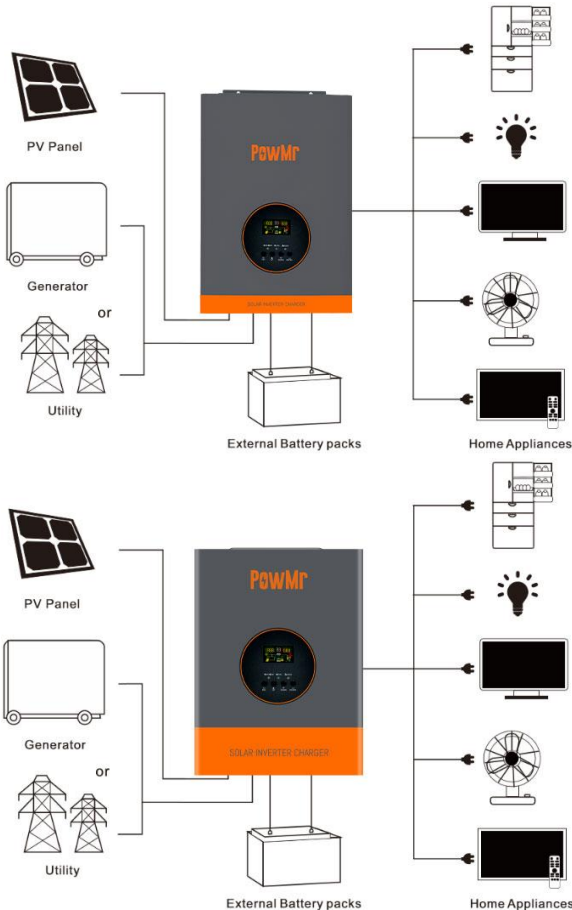

2.3 Product Appearance

2.3.1 3KW Model (POW-RELAB 3KE/ POW-RELAB 3KU)

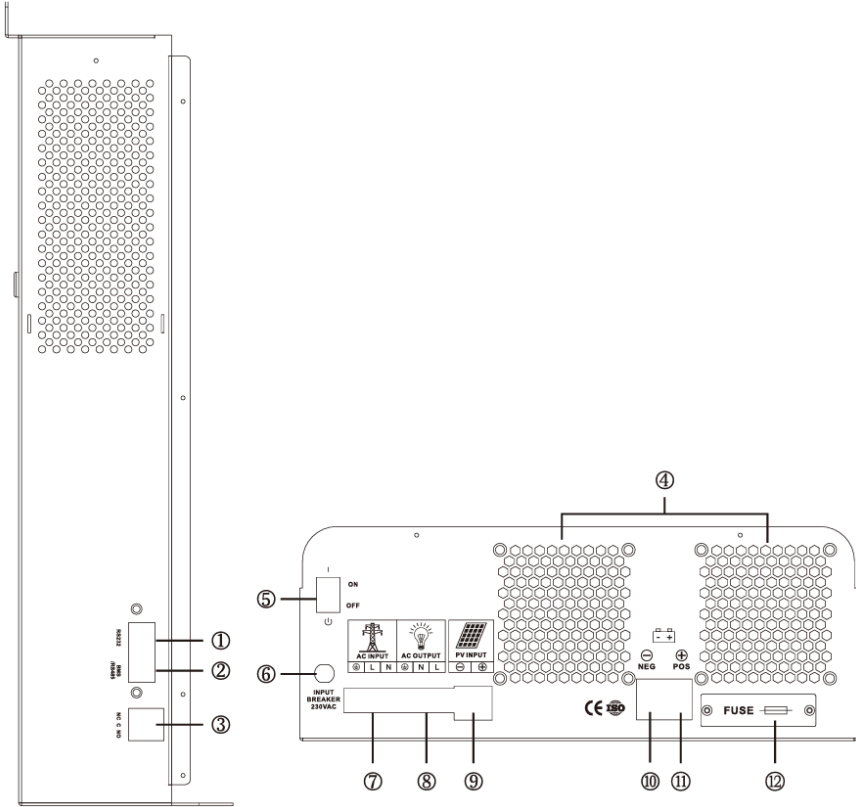

①	RS232 communication interface	⑦	AC input
②	BMS/RS485 communication interface	⑧	AC output
③	Dry contact ports	⑨	Photovoltaic input
④	Fan	⑩	Battery negative terminal
⑤	Toggle switch	⑪	Battery positive terminal
⑥	Input overcurrent protector	⑫	Battery circuit fuse

2.3.2 5KW & 10KW Models (POW-RELAB 5KE/ POW-RELAB 5KU/ POW-RELAB 10KE/ POW-RELAB 10KU)

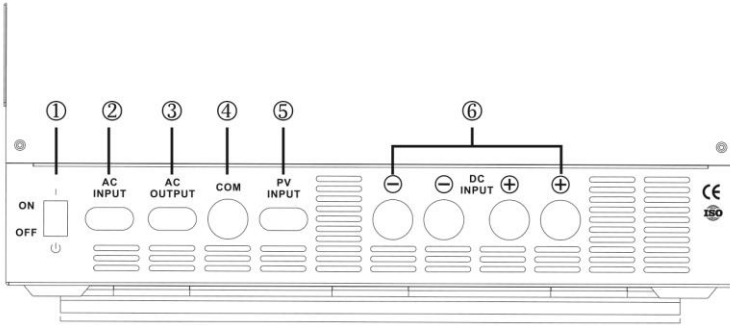

POW-RELAB 5KE/10KE/5KU

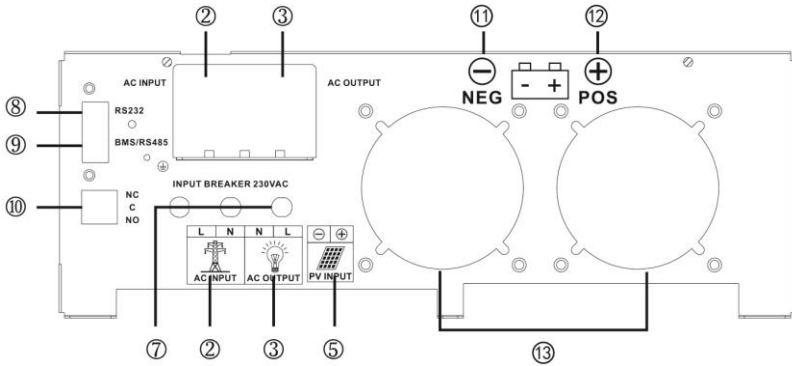

POW-RELAB 10KU

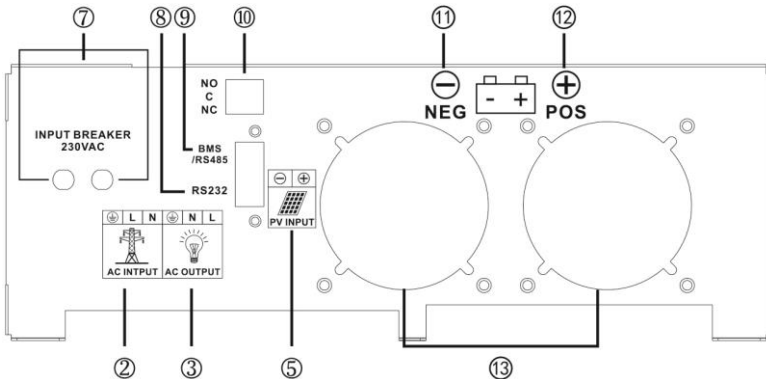

①	Toggle switch	⑧	RS232 communication interface
②	AC input	⑨	BMS/RS485 communication interface
③	AC output	⑩	Dry contact ports
④	Communication port	⑪	Battery negative terminal
⑤	PV input	⑫	Battery positive terminal
⑥	Battery input	⑬	Fan
⑦	Input overcurrent protector		

3 Assembly

3.1 Unboxing and Inspection













Before assembly, please inspect the unit to ensure that the items in the packaging are undamaged.

Inside the package, you will find the following items:

- Inverter device x1
- Explosion screws
- Instruction manual x1
- Battery fuses

3.2 Installation Tools

Before installation, please prepare the following tools.

Category	Tools		
General Tools	Multimeter 	Protective gloves 	Insulated safety shoes 
	Protective clothing 	Safety goggles 	Antistatic wrist strap 
Installation Tools	Electric screwdriver 	Socket wrench 	Wire stripper 
	Phillips screwdriver (M4/M6) 	Electric drill 	Hammer 

3.3 Equipment Installation

Before selecting an installation location, consider the following points:

- Do not install the inverter on combustible building materials.
- Install on a solid surface.
- Position the inverter at eye level for easy viewing of the LCD display.
- Maintain approximately 20cm spacing on each side and approximately 50cm spacing above and below the device for proper air circulation and heat dissipation.
- Ensure ambient temperature remains between 0°C to 55°C for optimal operation.
- It is recommended to install the device vertically against the wall.
- Ensure other objects, as shown in the diagram, maintain sufficient distance from the inverter surface to ensure adequate heat dissipation and provide enough space for wiring removal.

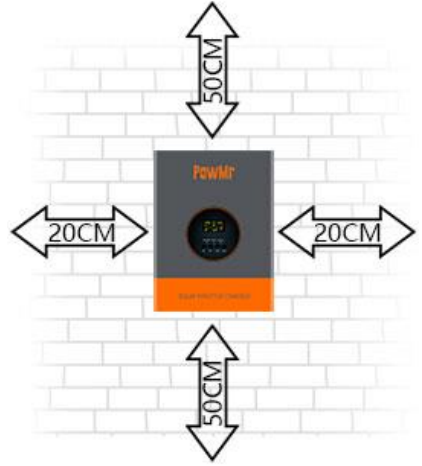

 **Suitable for installation on concrete or other non-combustible walls.**

Secure the device in place using two screws, preferably M4 or M5 screws.

3.4 Wiring Preparation

Loosen the fixed screws of the wiring terminal cover plate and remove the cover plate.

4 Wiring

4.1 Cable Size and Circuit Breaker Specifications

➤ PV IN

The configuration of the photovoltaic input cable depends on the actual power and voltage parameters of the photovoltaic array.

- * Required Parameters: Photovoltaic input power, Photovoltaic input voltage
- * Wire Size Configuration: Photovoltaic input power / Photovoltaic input voltage / 5

For example: If the photovoltaic array has a power of 1600W and a voltage of 144V, the wire size is calculated as follows:

$1600 / 144 / 5 \approx 2.22\text{mm}^2$, so the wire size can be chosen as 3mm^2 .

- * Circuit Breaker Configuration: Photovoltaic input power / Photovoltaic input voltage

For example: If the photovoltaic array has a power of 1600W and a voltage of 144V, the circuit breaker specification is calculated as follows:

$1600\text{W} / 144\text{V} \approx 11.11\text{A}$, so the circuit breaker can be chosen as a model greater than 11.11A.

➤ AC IN

Model	Cable Diameter		Circuit Breaker Spec	
	220V	110V	220V	110V
3KW	4mm ²	10mm ²	≥20A	≥35A
5KW	6mm ²	16mm ²	≥30A	≥60A
10KW	16mm ²	25mm ²	≥63A	≥125A

➤ Battery

Model	Cable Diameter	Circuit Breaker Spec
3KW	25mm ² /15mm ² x2	125A
5KW	25mm ² /15mm ² x2	125A
10KW	50mm ² /25mm ² x2	250A

➤ AC OUT

Model	Cable Diameter		Circuit Breaker Spec	
	220V	110V	220V	110V
3KW	4mm ²	6mm ²	≥14A	≥28A
5KW	6mm ²	10mm ²	≥23A	≥46A
10KW	10mm ²	25mm ²	≥46A	≥91A

4.2 AC Input & Output Connection

1. Connect the live wire, neutral wire, and ground wire to the respective terminals of the mains input and AC output as illustrated below, and install circuit breaker protection devices that meet the requirements on each of the two lines.
2. Ensure proper grounding of the equipment for safety. Ensure all cables are installed correctly and securely tightened.

AC Input Wiring for 3KW Model:

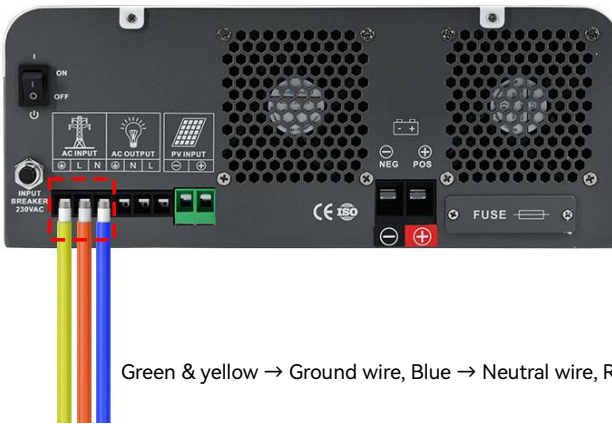

AC Output Wiring for 3KW Model:



AC Input Wiring for 5KW/10KW Model:

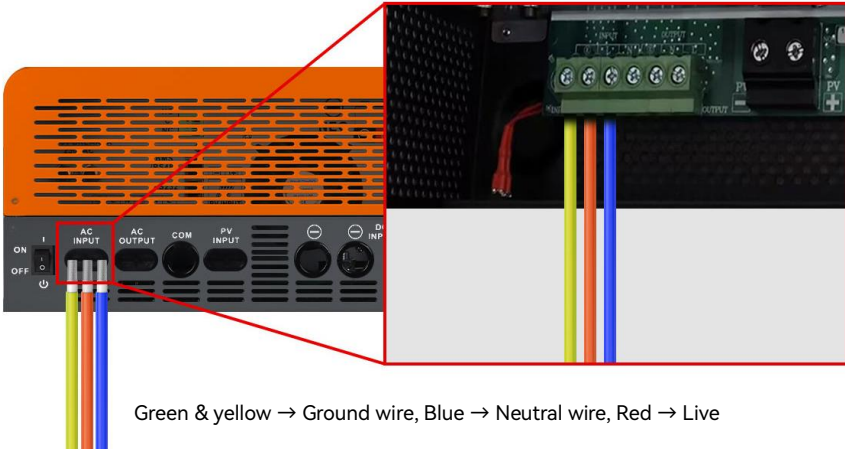

AC Output Wiring for 5KW/10KW Model:

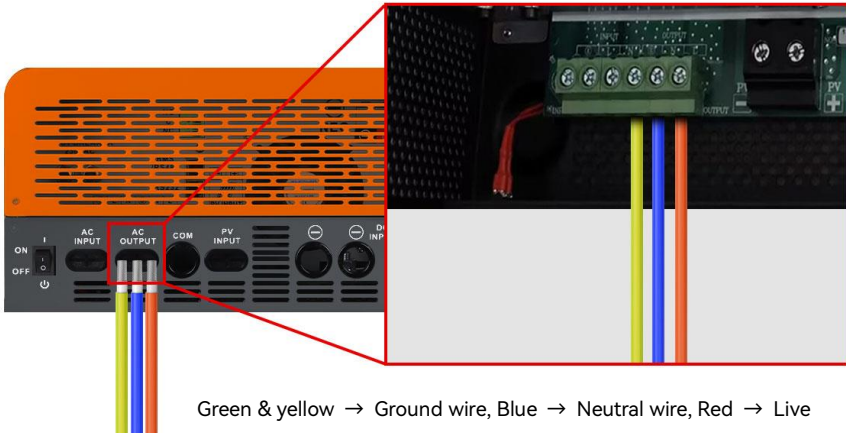

DANGER

- Before connecting the AC input and output, it is essential to open the circuit breaker to avoid the risk of electric shock. Do not perform any operations while the power is on.
- Please ensure that the cables used meet the requirements. Thin or poor-quality cables pose a serious safety hazard.

4.3 Battery Connection

Please connect the positive and negative terminals of the battery according to the diagram below. Be sure to install a circuit breaker that meets the specifications on the battery circuit.

Battery Connection for 3KW Model:

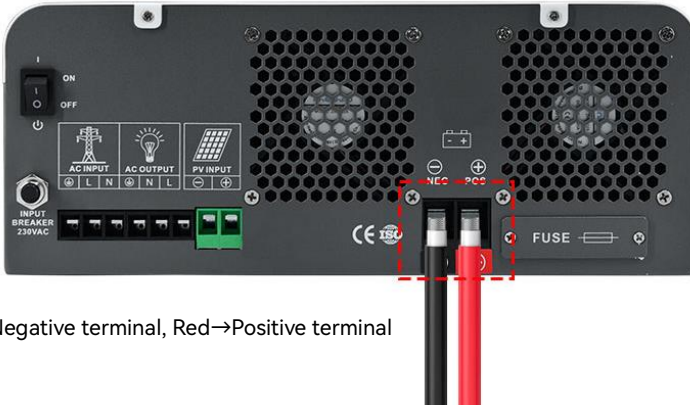

Black→Negative terminal, Red→Positive terminal

Battery Connection for 5KW/10KW Model:

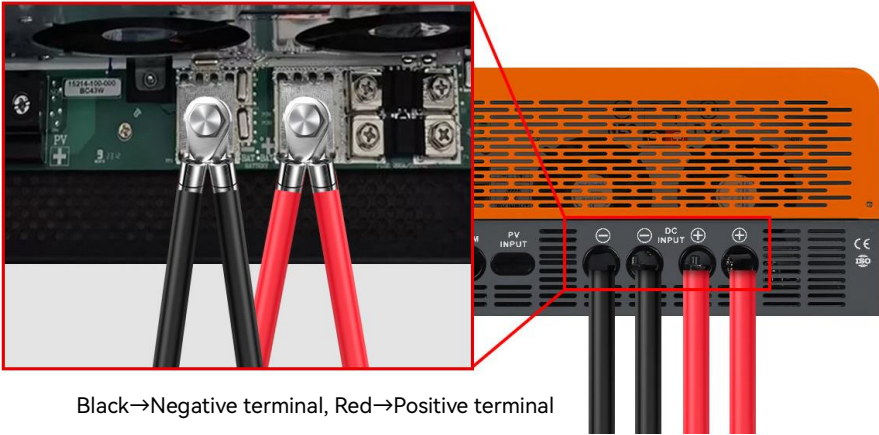

Black→Negative terminal, Red→Positive terminal

ATTENTION

- The POW-RELAB series inverters come standard with a fuse device for the battery circuit. Please use it according to actual needs.

DANGER

- Before connecting the battery, it is essential to disconnect the circuit breaker to avoid the risk of electric shock. Do not perform any operations while the power is on.
- Ensure that the positive and negative terminals of the battery are correctly connected and not reversed, as this could damage the inverter.
- Please ensure that the cables used meet the requirements. Thin or poor-quality cables pose a serious safety hazard.

4.4 Photovoltaic Connection

Please connect the photovoltaic array according to the diagram below, and strictly adhere to the requirement of installing a circuit breaker that meets the specifications.

Photovoltaic Connection for 3KW Model:

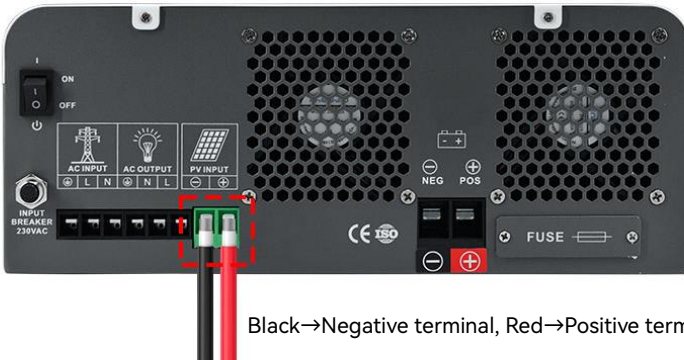

Black→Negative terminal, Red→Positive terminal

Photovoltaic Connection for 5KW/10KW Model:

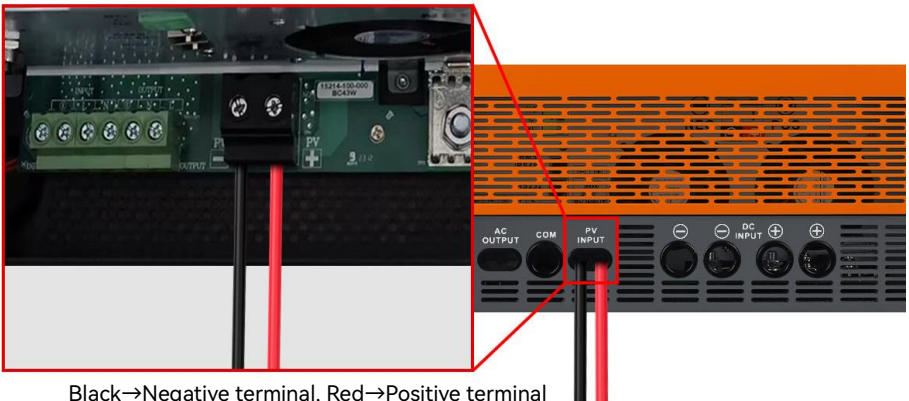

Black→Negative terminal, Red→Positive terminal

DANGER

- Before connecting the photovoltaic panels, it is essential to open the circuit breaker to avoid the risk of electric shock. Do not perform any operations while the power is on.
- Please ensure that the open-circuit voltage of the connected photovoltaic modules in series does not exceed the maximum open-circuit voltage of the inverter (which is 150V in the POW-RELAB series), as otherwise, the inverter may be damaged.

4.4.1 Selecting and Configuring Photovoltaic Panels

The following parameters are obtained from the specifications of photovoltaic panels:

- Pmax: Maximum output power (W)
- Voc: Open-circuit voltage (V)
- Isc: Short-circuit current (A)
- Vpm: Rated voltage (V)
- Ipm: Rated current (A)

Photovoltaic panels can be connected in series or parallel to obtain the required output voltage and current to meet the photovoltaic input range allowed by the solar controller and inverter-charger.

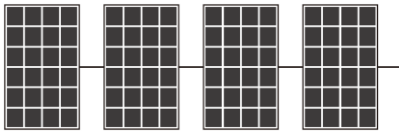

When photovoltaic panels are connected in series, the total voltage and current are:

$$V_{string} = V1 + V2 + V3 + V4...$$

$$I_{string} = I1 = I2 = I3 = I4 = ...$$

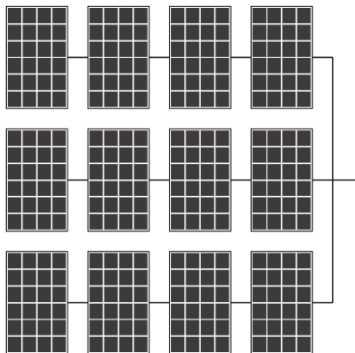

When parallel-connected photovoltaic panels are connected in parallel, the total voltage and current are:

$$V_{total} = V_{string1} = V_{string2} = V_{string3} = ...$$

$$I_{total} = I_{string1} + I_{string2} + I_{string3} + ...$$

- In any scenario, the total output power is equal to the power of a single photovoltaic panel multiplied by the total number of panels. The guideline for configuring photovoltaic panels is that the total power should be equal to or slightly greater than the maximum allowable PV power of the solar controller (refer to the technical specifications table). Excess capacity of photovoltaic panels does not contribute to the capacity of the solar charger; it only leads to higher installation costs.
- The total I_{pm} of photovoltaic panels should be less than the maximum charging current of the inverter.
- The total V_{oc} of photovoltaic panels should be less than the maximum PV input voltage of the inverter (refer to the technical specifications table).

Example: Taking a **48V** inverter as an example, selecting suitable photovoltaic components. Considering two scenarios for the built-in charging module of the inverter: The maximum photovoltaic input for PWM controller is 105V. The maximum photovoltaic input for MPPT controller is 150V. The total power should be equal to or slightly greater than 3200W. We can choose the following specifications for photovoltaic panels:

Maximum power $P_{max}(W)$	80W	Number of photovoltaic panels in each series: MPPT→4 panels ($421.6V < 105V$) MPPT→6 panels ($621.6V < 150V$)
Rated voltage $V_{pm}(V)$	18V	
Rated current $I_{pm}(A)$	4.46A	Total number of photovoltaic panels: 40 pieces→3200W/80W: 40 (panels) Number of parallel-connected groups: PWM→10 groups ($40/4=10$ groups) MPPT→7 groups ($40/6=7$ groups)
Open-circuit voltage $V_{oc}(V)$	21.6V	
Short-circuit current $I_{sc}(A)$	4.8A	

Configuration scheme for 48V inverter:

PWM controller: 4 panels of photovoltaic panels are connected in parallel to the inverter, with 10 groups of panels connected in parallel.

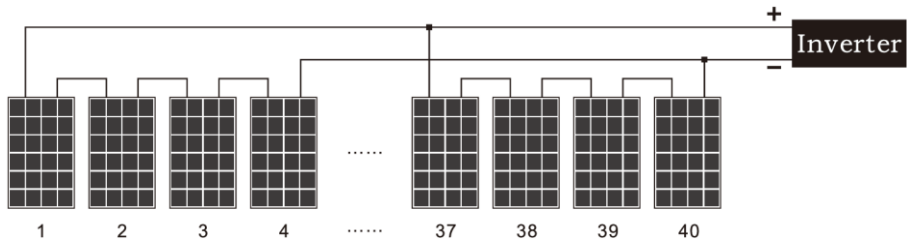

MPPT controller: Every 6 panels of photovoltaic panels are connected in series to form one group, and 7 groups of photovoltaic panels are connected in parallel.

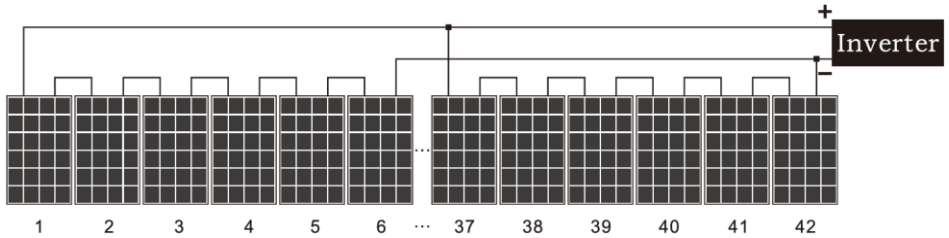

➤ Solar panel daily output = Total power of solar panel x Controller conversion efficiency x Local average sunlight time.

4.5 Final Assembly

After confirming all connections are accurate and tightened, please reinstall the port protective cover onto the device.

4.6 Communication Connection

4.6.1 BMS Communication

When the BMS communication interface is externally connected, the pin definitions are as follows:

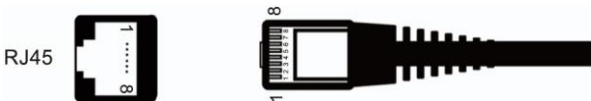

Pin	Definition
PIN1	485B
PIN2	485A
PIN3/4/5/6/7/8	NC

4.6.2 Dry Contact Function

Operating Principle: Dry contacts can control the AC input switch for battery charging.

Device Status	Condition		Dry Contact Port:		
			NC&C	NO&C	
Power Off	Device is turned off with no output power.		Close	Open	
Power On	Output powered by battery or solar energy.	Normal Mode	Battery voltage < DC undervoltage alarm voltage.	Open	Close
			Battery voltage > Float charge voltage.	Close	Open
		Solar Priority Mode	Battery voltage < Solar switching to AC power voltage.	Open	Close
			Battery voltage > AC power switching to DC power voltage.	Close	Open



5 Operation

5.1 Starting the Inverter

After closing the circuit breaker of the battery line, start the inverter by using the boat-shaped switch at the bottom. Once the inverter starts up normally, sequentially close the circuit breakers of the photovoltaic input, AC input, and AC output lines.



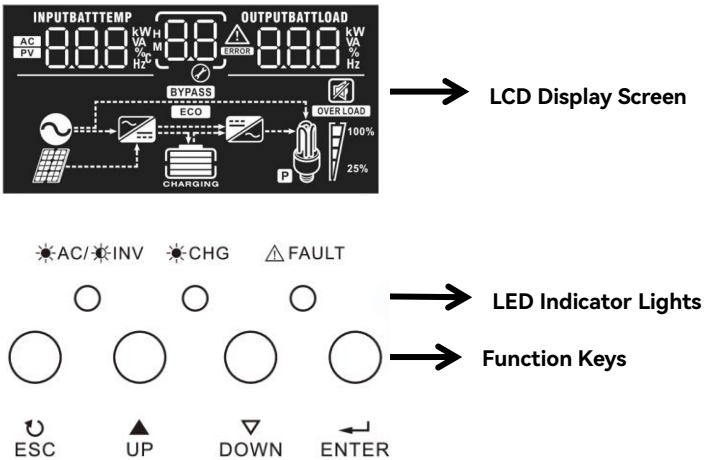

5.2 Introduction to the Operation Panel



➤ LED Indicator Lights







LED Indicator Light		Instruction	
☀️ AC/🔌 INV	Green	Steady On	In mains mode, output is powered by mains electricity.
		Flashing	In battery mode, output is powered by battery or PV.
🔋 CHG	Yellow	Steady On	Battery fully charged.
		Flashing	Battery charging in progress.
⚠️ FAULT	Red	Steady On	The inverter is in the fault state.

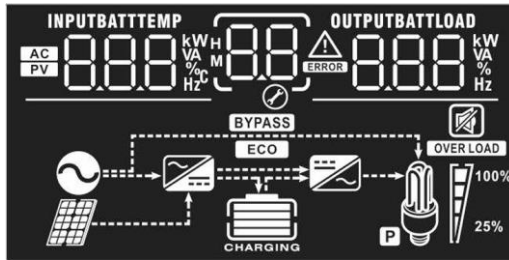











➤ Function Keys

Function Key	Instructions
 ESC	Exit setup mode.
 UP	Go to the previous selection.
 DOWN	Go to the next selection.
 ENTER	Confirm selection or enter setup mode in setup mode.

5.3 Display Panel Introduction



Icons	Function
Input Power Information	
	Indicates AC input.
	Indicates photovoltaic input.
INPUTBATT 	Indicates input voltage, battery voltage, device temperature, photovoltaic input voltage, operating mode, firmware version.
Configuration and Fault Information	
	Page number indication.
	Indicates alarm and fault codes. Alarm:  Flashing with alarm code.

	Fault:  Steady on with fault code.						
Output Information							
	Indicates output voltage, charging current, load percentage, photovoltaic input current, charging mode, firmware version.						
Battery Information							
	In battery mode and mains mode, charging status is represented by 0-24%, 25-49%, 50-74%, and 75-100% indicating battery level.						
In mains mode, it represents battery charging status.							
In battery mode, it represents battery capacity.							
Load Information							
OVER LOAD Indicates load.							
	Represents load levels of 0-24%, 25-49%, 50-74%, and 75-100% respectively.						
0%~24%		25%~49%		50%~74%		75%~100%	
							
Indicates device connected to mains.							
	Mains power indication.						
	PV input indication.						
BYPASS Bypass indication.							
	Rectifier circuit indication.						
	Inverter circuit indication.						
Silent Operation							
	Indicates alarm buzzer function is turned off.						

5.4 Interface Overview



Middle Display	Left Display	Right Display
P0	AC Input Voltage	AC Output Voltage
P1	Battery Voltage	Charging Current
P2	Device Temperature	Load Percentage
P3	Photovoltaic Input Voltage	Photovoltaic Input Current
P4	Operating Mode	Charging Mode
U0	Firmware Version	
U1		

5.5 Operating Modes

5.5.1 Grid Mode

Press the power button to start the device. When grid power is available, the inverter operates in grid mode, and the green "AC" indicator light remains steady.

5.5.2 Inverter Mode

In the event of a grid power outage or generator failure, the device switches to inverter mode, providing direct power to the load. The transition time is less than 10 milliseconds, ensuring uninterrupted operation of computers and other electronic devices. The green "INV" indicator light on the LCD screen will blink.

5.5.3 Charging Mode

When grid power or generator power is restored, the inverter enters charging mode. The green "AC" indicator light remains steady, while the yellow "CHG" indicator light starts blinking. Once the battery is fully charged, the blinking yellow indicator light changes to steady.

5.5.4 Alarm Mode

In case of a device malfunction, the red "FAULT" indicator light illuminates along with an audible alarm.

5.5.5 Bypass Function

When the device is turned off and grid power or generator power is available, the output terminals receive output voltage and begin charging. If there is no grid power or generator power, the output terminals do not supply voltage.

5.5.6 Energy-saving Mode

If there is no AC power input, the inverter's AC output will only supply power when a load greater than 15 watts is connected. It automatically checks the connected load every 25 seconds.

5.6 LCD Screen Settings

➤ **To enter the settings mode, follow these basic steps and configure the program as needed:**

1. Enter settings mode: Long press the ENTER button for 10 seconds.
2. Exit mode: Press the ESC button multiple times.
3. Select the parameter to be modified using the UP/DOWN buttons, then press ENTER to confirm.
4. The parameter will blink, allowing you to change it using the UP/DOWN buttons. Once done, press ENTER and wait for the settings to be completed.

➤ **LED Signal Indicator Display:**

1. During settings: The setting icon will blink.
2. Upon successful setting: The border on the left side of the parameter blinks.
3. In case of setting failure: "ERROR" is displayed, and the fault indicator light is on.

Item	Left Display	Middle Display	Right Display	Parameter Setting Range	Explanation
Grid Input Voltage Range	Alr	00	UPS	Narrow Range	Grid input range: KE Model: 180~265Vac ±3V KU Model: 92~132Vac ±3V
			APL default	Wide Range	Grid input range: KE Model: 155~265Vac ±3V KU Model: 77~132Vac ±3V
Grid Frequency Range	AFr	01	LO	Narrow Range	Grid input range: 45~65Hz
			HI default	Wide Range	Grid input range: 40~65Hz
Operating Mode	None	02	UTI default	Grid Priority	Grid power is prioritized to supply the load. Solar energy and battery power supply the load only when grid power is insufficient.
			SOL	Solar Priority	When solar power is sufficient, it will be the primary source for powering the load. If solar power is insufficient, both solar and

					<p>battery power will supply the load simultaneously.</p> <p>Additionally, if the battery voltage reaches the low battery warning level or the preset voltage point for switching from DC output to AC output, the power supply to the load will switch to the grid. The battery power is only activated when solar power is available. If there is no PV input, the battery will stop supplying power, and the grid will power the load.</p>
			SBU	Inverter Priority	<p>When solar power is sufficient, it will be the primary source for powering the load. If solar power is insufficient, both solar and battery power will supply the load simultaneously. When no solar power is available, the battery will power the load. If the battery voltage drops to the low battery warning level or the preset voltage point for switching from DC output to AC output, the power supply to the load will switch to the grid.</p>
Charging Mode	None	03	CUT default	Grid Priority	Both grid input and solar energy charge the battery simultaneously.
			CSO	Solar Priority	In solar priority mode, if solar energy is available, the

					inverter will prioritize using solar energy to charge the battery. When the battery voltage drops below the setting value of item 09, the charging source automatically switches to grid power. When the battery voltage exceeds the setting value of item 10, the charging source automatically switches to solar energy.
			OSO	Solar Charging Only	Only solar energy is allowed as the charging source.
Grid Charging Current Percentage	ACP	04	100%	10~100%	Set the percentage of grid charging current.
Solar Charging Current Percentage	SCP	05	100%	20~100%	Set the percentage of solar charging current.
Boost Charging Voltage (CV)	CU	06	14.2V	13.5~15.0V	Set the boost charging voltage, i.e., constant voltage charging voltage. Please strictly follow the parameters in the battery specification for setting.
			28.4V	27.0~30.0V	
			56.8V	54.0~60.0V	
Float Charging Voltage	FLU	07	13.6V	12.5~14.0V	Set the float charging voltage for the battery.
			27.2V	25.0~28.0V	Please strictly follow the parameters in the battery specification for setting.
			54.0V	50.0~56.0V	

Battery Discharge Cutoff Shutdown Voltage	COU	08	10.2V	9.5~11.5V	Set the shutdown voltage point for battery protection. When the battery voltage drops below this set value, the inverter will automatically shut down to prevent deep discharge of the battery.
			20.4V	19.0~23.0V	
			40.8V	38.0~46.0V	
Enable Grid Charging Voltage	DTA	09	12.0V	11.5~12.5V	Configure the voltage value of grid power used for charging the battery in solar priority charging mode.
			24.0V	23.0~25.0V	
			48.0V	46.0~50.0V	
Exit Grid Charging Voltage	ATD	10	13.5V	13.0~14.0V	Stop using the voltage value of grid power for charging the battery in solar priority charging mode.
			27.0V	26.0~28.0V	
			54.0V	52.0~56.0V	
Inverter Output Voltage	OU	11	220V	200~240V	Set the inverter output voltage.
Grid Detection Speed	CST	12	HI	Fast	Grid sensitivity setting, configuring the response speed for grid power fluctuations.
			IDE default	Medium	
			LO	Slow	
Inverter Output Frequency	OF	13	50Hz default		Set the inverter output frequency.
			60Hz		
Fault Restart Switch	RA	14	TE default	Enabled	Automatically restarts three times in case of short circuit or overload faults.
			TD	Disabled	Does not restart in case of short circuit or overload

					faults.
Backlight Control	BLC	15	LON	Always On	Backlight remains on and does not turn off.
			LOF	Always Off	Backlight remains off and does not turn on.
			LOD default	Delayed Off	Automatically turns off backlight after 1 minute of inactivity.
Buzzer Control Switch	BEC	16	AON default	Enabled	When enabled, the buzzer will sound an alarm in case of device faults.
			AOF	Disabled	When disabled, the buzzer will not sound in case of device faults.
Battery Under Voltage Alarm Switch	BOL	17	Off	Disabled	Defaulted to enabled. This is an intelligent battery protection feature, and it is not recommended to change.
			On default	Enabled	
Load Limitation	LL	18	Off	Disabled	Defaulted to enabled. This is an intelligent battery protection feature, and it is not recommended to change.
			On default	Enabled	
/	LEL	19	This model does not support this setting for now.		
Baud Rate	BAU	20	0 default	2400	Set communication baud rate.
			1	4800	
			2	9600	
Inverter Output Mode	ODT	21	220	220	Set to display output voltage. This is only for adjusting the display and does not change the inverter output voltage.
			110	110	

Startup Battery Voltage	BLS	22	11.5V	10.5~12.2V	After abnormal shutdown of the inverter, the device can only be manually restarted if the battery voltage is higher than this set value.
			23.0V	21~24.4V	
			46.0V	42~48.8V	
Undervoltage Shutdown Recovery Voltage	BLS	23	13.0V	12~14V	After shutdown due to battery undervoltage, the inverter can automatically restart when the battery voltage exceeds this set value.
			26.0V	24~28V	
			52.0V	48~56V	
Battery Type	BTT	24	SEL	SEL	Sealed Lead Acid Battery
			GEL	GEL	Gel Sealed Lead Acid Battery
			FLD	FLD	Flooded Lead Acid Battery
			USER default	USER	User Defined
			TER	LiCoMnNiO2	Lithium-ion Battery
			LIF	BAT- LiFePOW4	Lithium Iron Phosphate Battery
BMS Function Switch	BnS	25	OFF default	ON	Enable BMS communication function. When enabled, settings 26~29 can be effectively configured and executed.
				OFF	Disable BMS communication function.
Undervoltage Shutdown SOC	BSU	26	10% default	5~50%	Configuration of BMS undervoltage shutdown SOC. When the battery SOC is detected below the set value, the inverter will automatically

					shut down to protect the battery.
Switch to Utility Mode SOC	STG	27	20% default	5~50%	If the inverter operation mode is set to Battery Priority Mode, when the battery SOC is below the set value, it will forcibly switch to utility charging mode.
Switch to Inverter Mode SOC	STB	28	95% default	50~100%	If the inverter operation mode is set to Battery Priority Mode, when the battery SOC is above the set value, it will revert to battery inverter operation mode.
Restart SOC	BSR	29	50% default	30~100%	After the inverter is powered on, it can only operate normally when the SOC is above the set value.
Restore Factory Settings	RS	30	OFF default	ON	Restore factory settings.
				OFF	/
ECO Energy Saving Mode	ECO	None	OFF default	ON	Enable energy-saving mode.
				OFF	Disable energy-saving mode.

6 Troubleshooting

6.1 Alarms

Left Display	Right Display	Instructions
ALA	021	Device Communication Connection Failure
ALA	233	Abnormal Utility Output
ALA	236	Abnormal Load in the Device
ALA	237	Overload in the Device
ALA	231	Abnormal Inverter Output
ALA	234	High Battery Voltage
ALA	235	Low Battery Voltage
ALA	241	Storage Chip Data Read/Write Error
ALA	232	Storage Chip Connection Failure
ALA	238	Device Overtemperature
ALA	239	Inverter Temperature Too High Due to Connected Load
ALA	242	Shutdown Executed by Upper Computer Software
ALA	244	BMS-Other Faults
ALA	245	BMS-Communication Anomaly
ALA	246	BMS-Charging Overcurrent
ALA	247	BMS-Discharging Overcurrent
ALA	248	BMS-Overtemperature
ALA	249	BMS-Low Temperature

6.2 Alarm Event

Audible alarm	Buzzer Alarm
Low battery	Audible alarm - Beeping for 1 second
Overload	Audible alarm - Continuous beeping
Fault	Audible alarm - Continuous beeping

6.3 Errors

Left Display	Right Display	Instructions
FAL	102	Inverter Overload Shutdown
FAL	104	Abnormal Inverter Output
FAL	105	Inverter Load Abnormality
FAL	106	Inverter Overtemperature
FAL	135	High Battery Voltage
FAL	134	Low Battery Voltage
FAL	123	Connected Load Causes Inverter Overtemperature
FAL	169	Current Detection Signal Failure
FAL	161	Abnormal Utility Output
FAL	152	Temperature Sensor Connection Failure
FAL	162	Shutdown Executed by Upper Computer Software

6.4 Troubleshooting

Issue	Possible Causes	Solution
Inverter fails to operate properly after startup	Battery terminals not tightened	Tighten the battery terminals.
Sparking observed at inverter terminals	Reverse polarity connection	Inspect the polarity of the terminals and reconnect them correctly.
No output from the inverter	Output terminal rows not tightened	Remove the port cover and tighten the corresponding terminal rows.
Inverter unable to charge	Input voltage less than 150Vac	Increase the voltage using a stabilizer.
Continuous alarm from inverter buzzer during load operation	Inverter overload	Check the load and reduce high-power loads.

7 System Maintenance

1. To maintain optimal and long-term performance, it is recommended to conduct the following checks twice a year:
2. Ensure that the airflow around the all-in-one machine is not obstructed, and clear any dirt or debris from the heat sink.
3. Inspect all exposed wires for damage to insulation caused by exposure to sunlight, friction with surrounding objects, dryness, insect or rodent damage, etc. Repair or replace wires as necessary.
4. Verify that the indicators and displays are consistent with equipment operation. Take corrective action if any faults or error displays are observed.
5. Inspect all terminal connections for corrosion, insulation damage, high temperature, or signs of burning/discoloration. Tighten terminal screws.
6. Check for dirt, nesting insects, and corrosion, and clean as required.
7. If surge protectors have failed, promptly replace the failed surge protectors to prevent damage from lightning strikes to the all-in-one machine or other user equipment.

*** The following damages are not covered by the company's liability:**

1. Damage caused by improper use or use in inappropriate locations.
2. Damage caused by the open-circuit voltage of photovoltaic modules exceeding the maximum allowable voltage.
3. Damage caused by operating environment temperatures exceeding the limited operating temperature range.
4. Unauthorized disassembly and repair of the all-in-one machine.
5. Damage caused by force majeure: damage occurring during transportation or handling of the all-in-one machine.

*** The following situations are not covered by the warranty:**

1. User-configured batteries.
2. Equipment damage caused by operation not in accordance with the user manual.
3. Machine damage caused by natural disasters such as fire, flood, etc.
4. Products beyond the warranty period are subject to paid repair services.

8 Specifications

8.1 Table 1: Utility Mode Parameters

Model	POW-RELAB 3KE	POW-RELAB 5KE	POW-RELAB 10KE
Input Voltage Waveform	Pure Sine Wave		
Nominal Input Voltage	220Vac		
AC Input Voltage Range	154~265Vac		
Nominal Input Frequency	50Hz / 60Hz (Auto Detection)		
Transfer Time	≤10ms (UPS); ≤20ms (APL)		
Input Protection	Circuit Breaker		
Output Protection	Circuit Breaker		

Model	POW-RELAB 3KU	POW-RELAB 5KU	POW-RELAB 10KU
Input Voltage Waveform	Pure Sine Wave		
Nominal Input Voltage	110Vac		
AC Input Voltage Range	77~132Vac		
Nominal Input Frequency	50Hz / 60Hz (Auto Detection)		
Transfer Time	≤10ms (UPS); ≤20ms (APL)		
Input Protection	Circuit Breaker		
Output Protection	Circuit Breaker		

8.2 Table 2: Inverter Mode Parameters

Model	POW-RELAB 3KE	POW-RELAB 5KE	POW-RELAB 10KE
Rated Output Power	3000W/3800VA	5000W/6300VA	10000W/12500VA
Output Voltage Waveform	Pure Sine Wave		
Output Voltage Range	220Vac±10%		
Output Frequency	50Hz / 60Hz		
Peak Power	9000W	15000W	30000W
Efficiency	>98%		
Bypass Mode	Integrated		
Eco Mode	Integrated		
Nominal DC Input Voltage	24Vdc	48Vdc	

Model	POW-RELAB 3KU	POW-RELAB 5KU	POW-RELAB 10KU
Rated Output Power	3000W/3800VA	5000W/6300VA	10000W/12500VA
Output Voltage Waveform	Pure Sine Wave		
Output Voltage Range	110Vac±10%		
Output Frequency	50Hz / 60Hz		
Peak Power	9000W	15000W	30000W
Efficiency	>98%		
Bypass Mode	Integrated		
Eco Mode	Integrated		
Nominal DC Input Voltage	24Vdc	48Vdc	

8.3 Table 3: Charging Mode Parameters

Model	3KW	5KW	10KW
Battery			
Battery Type	AGM, FLD, GEL, Lithium battery		
Battery Charging Voltage	27.4VDC	54.8VDC	54.8VDC
Battery Undervoltage Cutoff Voltage	20V/21V	40V/42V	
Battery Undervoltage Warning Voltage	Mild discharge: 23V; Loaded discharge: 23V @ load < 20% / 22V @ load > 50% / 21V @ load > 50%	Mild discharge: 46V; Loaded discharge: 46V @ load < 20% / 44V @ load > 50% / 42V @ load > 50%	
Battery Undervoltage Recovery Voltage	Mild discharge: 24V; Loaded discharge: 24V @ load < 20% / 23V @ load > 50% / 22V @ load > 50%	Mild discharge: 48V; Loaded discharge: 48V @ load < 20% / 46V @ load > 50% / 44V @ load > 50%	
Battery Undervoltage Shutdown Voltage	Mild discharge: 22V; Loaded discharge: 22V @ load < 20% / 21V @ load > 50% / 20V @ load > 50%	Mild discharge: 44V; Loaded discharge: 44V @ load < 20% / 42V @ load > 50% / 40V @ load > 50%	
Battery Overvoltage Warning Voltage	32V	64V	
Battery Overvoltage Recovery Voltage	30V	60V	
PV Input			
Max. PV Array Power	1600W	6400W	6400W
MPPT Input Voltage Range	30~150Vdc	60~150Vdc	
Max. PV Array Open Circuit Voltage	150Vdc		
Charging Current			
Maximum AC Charging Current	38A	29A	60A
Max. PV Charging Current	60A	120A	

8.4 Table 4: General Parameters

Model	POW-RELAB 3KE	POW-RELAB 5KE	POW-RELAB 10KE
Operating temperature	-10°C to 50°C		
Storage temperature	-15°C to 50°C		
Humidity	Relative humidity from 5% to 95% (non-condensing)		
Noise	< 45dB		
Dimensions (LxWxH)	465*310*135mm	545*400*200mm	
Net weight	19kg	27.4kg	51kg

Model	POW-RELAB 3KU	POW-RELAB 5KU	POW-RELAB 10KU
Operating temperature	-10°C to 50°C		
Storage temperature	-15°C to 50°C		
Humidity	Relative humidity from 5% to 95% (non-condensing)		
Noise	< 45dB		
Dimensions (LxWxH)	465*310*135mm	545*400*200mm	
Net weight	19kg	27.4kg	52kg