

LUXEN

LUXHYPER[®]

MONO

325-340w

LUXHYPER[®] series (Super-efficiency half-cell Modules) Assembled with the advanced half-cell technology offer the advantages of higher power output, reduced series resistance loss, and lower risk of hot spot. In order to meet the Clients' requirements of best quality and efficiency.

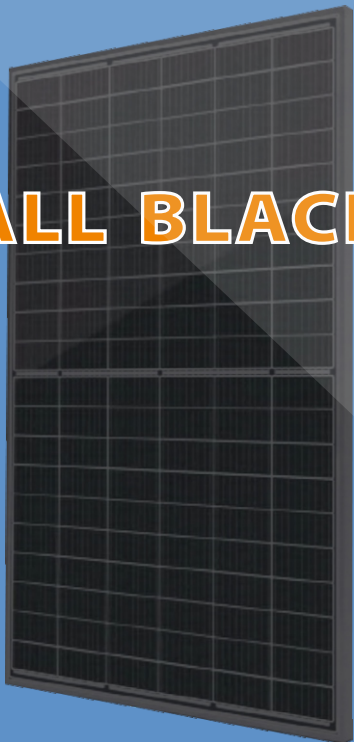

120 cells
Half-Cell Modules

ALL BLACK

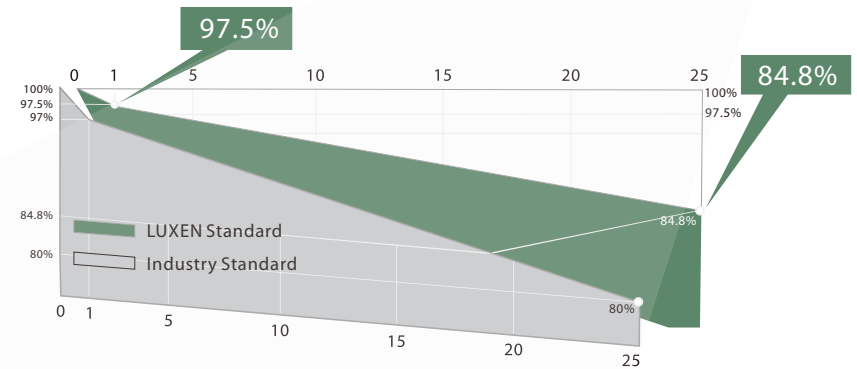

LINEAR PERFORMANCE WARRANTY



- 9BB** 9BB cell design
Smaller electric current, less CTM loss
Lower risk of hot spot
-  ISO9001:2015 QMS
ISO14001:2015 EMS
ISO45001:2018 OHSMS
- IEC** IEC61215&IEC61730
standard quality
-  Wind load up to 3800Pa
Snow load up to 5400Pa
- +5W** 0-5W positive power sorting
-  Stable performance under
weak light conditions
- 25-year
12-year** 25-year power warranty
12-year product warranty



MONO 325-340w 120 cells 9BB ALL BLACK

LUXEN

ELECTRICAL PARAMETERS

	LNSK-325M		LNSK-330M		LNSK-335M		LNSK-340M	
	STC	NOCT	STC	NOCT	STC	NOCT	STC	NOCT
Maximum Power (Pmax)	325W	242W	330W	246W	335W	250W	340W	254W
Open Circuit Voltage (Voc)	40.78V	38.00V	41.07V	38.38V	41.37V	38.72V	41.67V	39.06V
Short Circuit Current (Isc)	10.24A	8.21A	10.32A	8.26A	10.39A	8.32A	10.47A	8.37A
Voltage at Maximum Power (Vmp)	33.78V	33.70V	34.06V	34.02V	34.30V	34.31V	34.55V	34.60V
Current at Maximum Power (Imp)	9.62A	7.18A	9.69A	7.23A	9.77A	7.29A	9.84A	7.34A
Module Efficiency(%)	19.26%		19.56%		19.85%		20.15%	

STC: Irradiance 1000W/m², cell temperature 25°C, AM1.5G
NOCT: Irradiance 800W/m², ambient temperature 20°C, wind speed 1m/s, AM1.5G

LNSK-330M/I-V

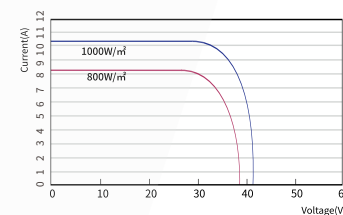

Operating Module Temperature	-40°C to +85°C
Maximum System Voltage	1500V DC(IEC)
Maximum Series Fuse Rating	20A
Power Tolerance	0/+5W
Temperature Characteristics	
Nominal Operating Cell Temperature(Noct)	45±2°C
Temperature Coefficient of Pmax	-0.36%/°C
Temperature Coefficient of Voc	-0.28%/°C
Temperature Coefficient of Isc	+0.05%/°C

Packing Configuration

Container	20'GP	40'HQ
Pieces per pallet	31	31
Pallets per container	12	26
Pieces per container	372	806

Mechanical Characteristics

Solar Cell	MONO158.75x79.375mm
No.of Cell	120(6x20)
Dimensions	1684x1002x35mm
Weight	19.0kgs
Front	3.2mm coated tempered glass
Frame	Anodized aluminium alloy
Junction Box	Ip68 rated(3 by pass diodes)
Output Cables	4.0mm ² 300mm(+)/300mm(-) Length can be customized
Connectors	MC4 compatible
Mechanical load test	5400Pa

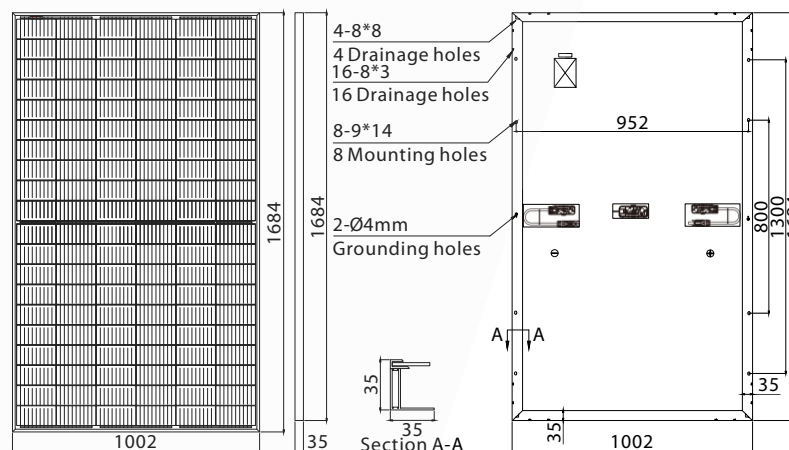

LUXEN SOLAR ENERGY CO., LTD
 T:+86 512 6708 1572
 F:+86 512 6708 1570
 sales@luxensolar.com
 www.luxensolar.com

Note: Due to continuous technical innovation, R&D and improvement, technical data above mentioned may be of modification accordingly. LUXEN SOLAR have the sole right to make such modification at anytime without further notice.

