

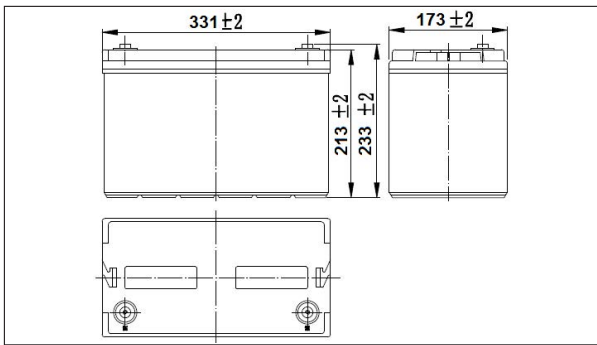

Specifications

Nominal Voltage		12V
Rated capacity (10 hour rate)		100Ah
Dimensions	Length	331 ± 2mm (13.03inch)
	Width	173 ± 2mm (6.81inch)
	Height	213 ± 2mm (8.39inch)
	Total Height	233 ± 2mm (9.17inch)
Approx. Weight		28.5kg (62.8lbs) ± 3%

Outer dimensions (mm)



Terminal Type (mm)

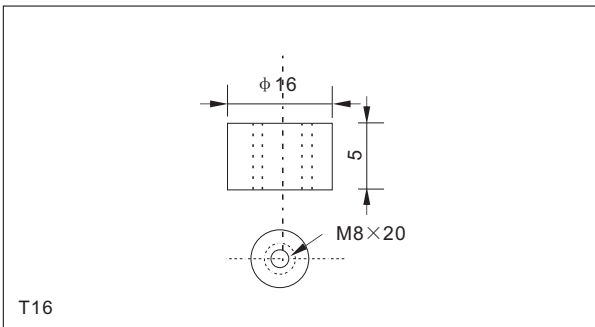

Characteristics

Capacity (25°C)	10HR(10.8V)	100Ah
	3HR(10.8V)	75Ah
	1HR(10.5V)	55.8Ah
Terminal type		T16
Internal resistance (Fully charged, 25°C)		Approx. 4.5m Ω
Capacity affected by temperature (20HR)	40°C	102%
	25°C	100%
	0°C	85%
	-15°C	65%
Self-discharge (25°C)	3 months	Remaining Capacity: 91%
	6 months	Remaining Capacity: 82%
	12 months	Remaining Capacity: 65%
Nominal operating temperature		25°C ± 3°C (77°F ± 5°F)
Operating temperature range	Discharge	-15°C ~ 50°C (5°F ~ 122°F)
	Charge	-10°C ~ 50°C (14°F ~ 122°F)
	Storage	-20°C ~ 50°C (-4°F ~ 122°F)
Float charging voltage (25°C)		13.50 to 13.80V Temperature compensation: -18mV/°C
Cyclic charging voltage (25°C)		14.50 to 15.00V Temperature compensation: -30mV/°C
Maximum charging current		30A
Maximum discharge current		800A (5 sec.)
Designed floating life (20°C)		10 years

Construction

Component	Positive plate	Negative plate	Container	Cover	Separator	Electrolyte	Safety valve	Terminal
Raw material	Lead dioxide	Lead	ABS	ABS	AGM	Sulfuric acid	Rubber	Copper

Constant Current Discharge Characteristics Unit: A (25°C, 77°F)

F.V/Time	10min	15min	30min	60min	2h	3h	4h	5h	8h	10h	20h
9.60V	195	160	97.0	60.0	36.5	26.0	20.4	17.3	12.2	10.2	5.40
9.90V	189	156	95.1	59.1	36.3	25.9	20.3	17.2	12.2	10.2	5.38
10.2V	181	150	92.2	57.6	36.0	25.7	20.1	17.1	12.1	10.1	5.37
10.5V	174	145	89.9	55.8	35.5	25.5	20.0	17.0	12.0	10.1	5.34
10.8V	164	138	86.6	54.0	34.6	25.0	19.4	16.5	11.6	10.0	5.30

Constant Power Discharge Characteristics Unit: W (25°C, 77°F)

F.V/Time	10min	15min	30min	60min	2h	3h	4h	5h	8h	10h	20h
9.60V	2106	1757	1088	684	423	306	240	205	145	122	64.7
9.90V	2043	1715	1067	674	421	304	238	204	145	121	64.6
10.2V	1959	1651	1034	657	417	302	237	202	144	121	64.4
10.5V	1874	1595	1009	636	411	300	235	201	143	120	64.0
10.8V	1769	1511	972	616	400	294	228	195	138	119	63.6

Note: The above characteristics data can be obtained within three charge or discharge cycles.

Discharge characteristics(25°C)

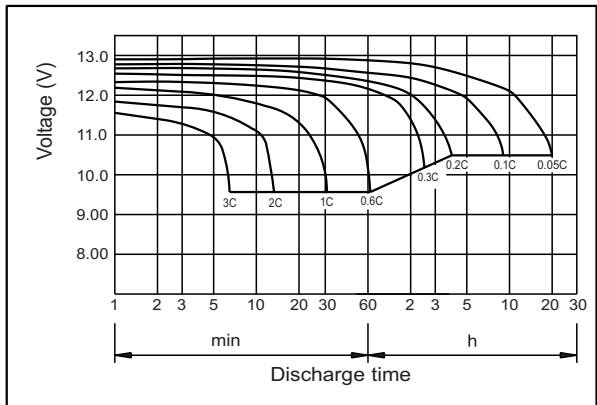

Charging characteristics (25°C)

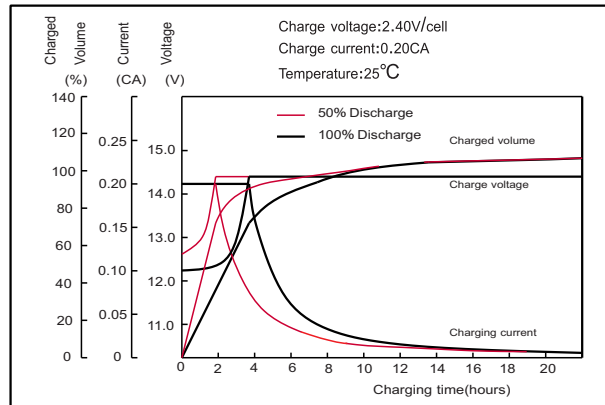

Temperature effects on Capacity

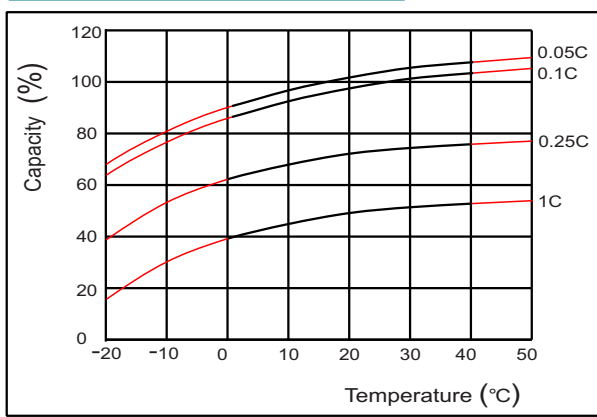

Self-discharge characteristics

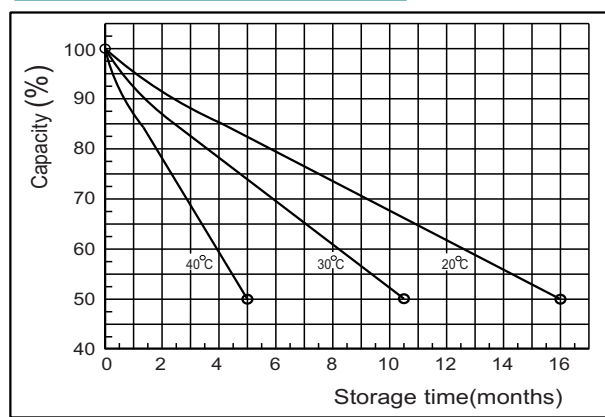

Floating life on Temperature

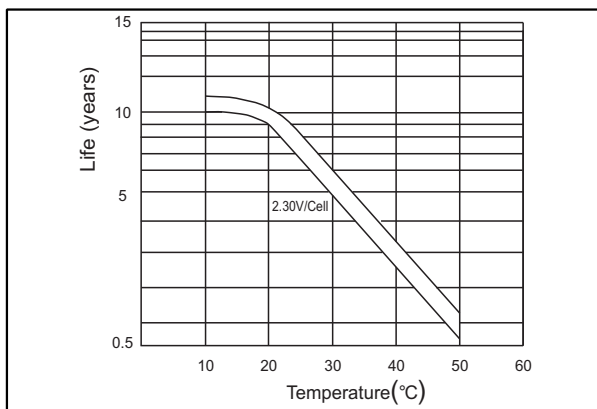

Cycle life on D.O.D (25°C)

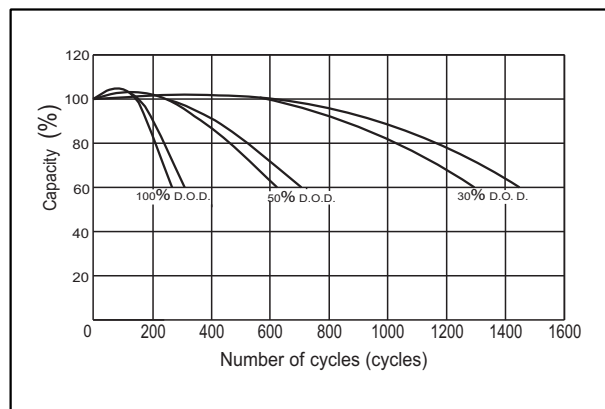

The relationship for OCV and Capacity (25°C)

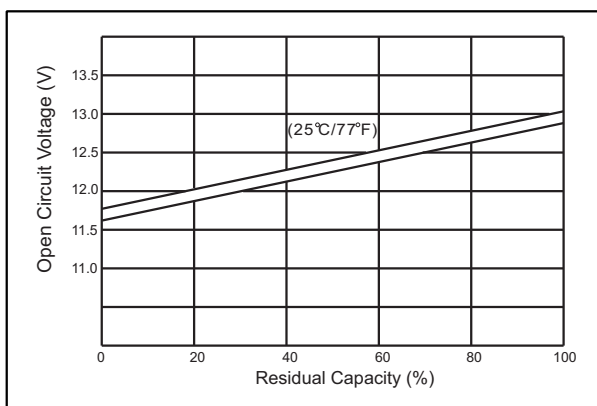

The relationship for Charging voltage and Temperature

