

The rechargeable batteries are lead-lead dioxide systems. The dilute sulfuric acid electrolyte is absorbed by separators and plates and thus immobilized. Should the battery be accidentally overcharged producing hydrogen and oxygen, special oneway valves allow the gases to escape thus avoiding excessive pressure build-up. Otherwise, the battery is completely sealed and is, therefore, maintenance-free, leak proof and usable in any position.



Battery Construction

Component	Positive plate	Negative plate	Container	Cover	Safety valve	Terminal	Separator	Electrolyte
Raw material	Lead dioxide	Lead	ABS	ABS	Rubber	Copper	Fiberglass	Sulfuric acid

General Feature

- Absorbent Glass Mat(AGM) technology for efficient gas recombination of up to 99% and freedom from electrolyte maintenance or water adding.
- Not restricted for air transport-complies with IATA/ICAO Special Provision A67.
- UL-recognized component.
- Can be mounted in any orientation.
- Computer designed lead, calcium tin alloy grid for high power density.
- Long service life, float or cyclic applications.
- Maintenance-free operation.
- Low self discharge.

Performance Characteristics

Capacity 77°F(25°C)	10 hour rate (35A、1.8V)	350Ah
	5 hour rate (61A、1.75V)	305Ah
	3 hour rate (90A、1.70V)	270Ah
	1 hour rate (215A、1.60V)	215Ah
Internal Resistance	Full charged Battery77°F(25°C): 0.8mΩ	
Capacity affected by Temperature (10 hour rate)	104° F(40°C)	102%
	77° F(25°C)	100%
	32° F(10°C)	85%
	5° F(-15°C)	65%
Self-Discharge 68°F(20°C)	Capacity after 3 month storage	90%
	Capacity after 6 month storage	80%
	Capacity after 12month storage	60%
Max. discharge current77°F(25°C): 1500A(5S)		
Charge (Constant Voltage)	Float: 2.25~2.30 V/77° F(25°C)	
	Cycle:2.35~2.45 V/77°F(25°C) Max. Current: 70A	

SPECIFICATION

- Nominal voltage 2V
- Number of cell 1
- Length(mm/inch) 171/6.73
- Width(mm/inch) 151/5.94
- Height(mm/inch) 330/13.0
- Total Height(mm/inch) 364/14.3
- Approx. Weight(kg/lbs) 20.5/45.2

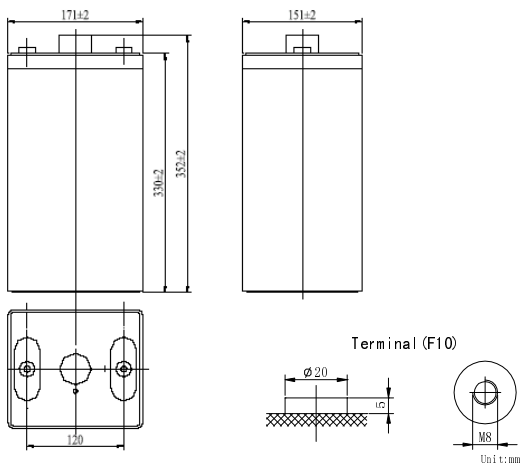

Total height with removable cover:364

Discharge Constant Current (Amperes at 77° F25 °C)

End Point Volts/Cell	5min	10min	15min	30min	45min	1h	3h	5h	10h
1.60V		571	513	348	278	215	97.5	66.0	37.2
1.65V		541	489	336	267	209	94.0	64.6	36.8
1.70V		510	464	325	255	203	90.0	62.8	36.3
1.75V		479	438	315	243	196	86.0	61.0	35.7
1.80V		446	411	301	230	188	81.0	59.0	35.0

Discharge Constant Power (watts at 77° F 25°C)

End Point Volts/Cell	5min	10min	15min	30min	45min	1h	2h	3h	5h
1.60V		1020	914	699	547	442	284	201	132
1.65V		960	869	668	529	426	277	196	130
1.70V		900	825	637	509	410	269	191	127
1.75V		841	780	606	491	393	261	186	124
1.80V		782	736	575	471	377	252	180	120

(Note)The above characteristics data are average values obtained Within three charge/discharge cycles not the minimum values.

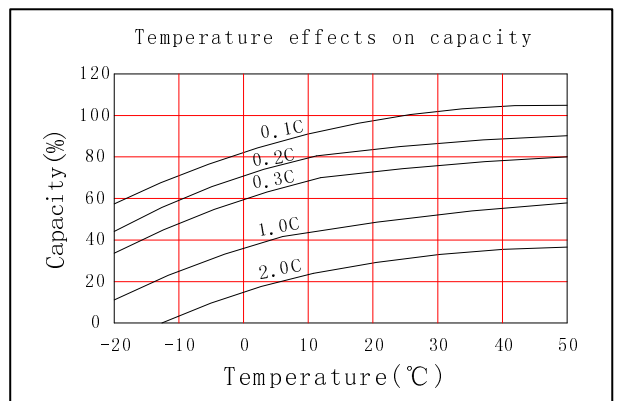
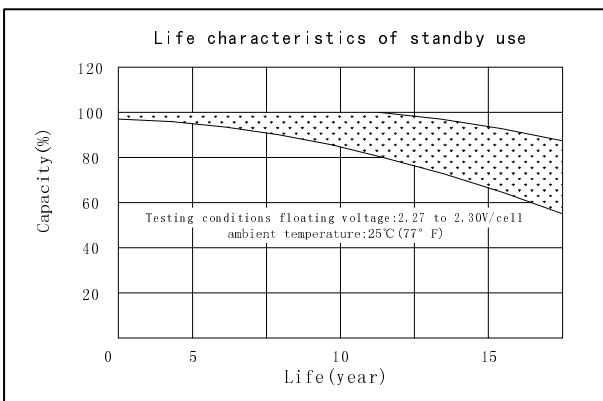
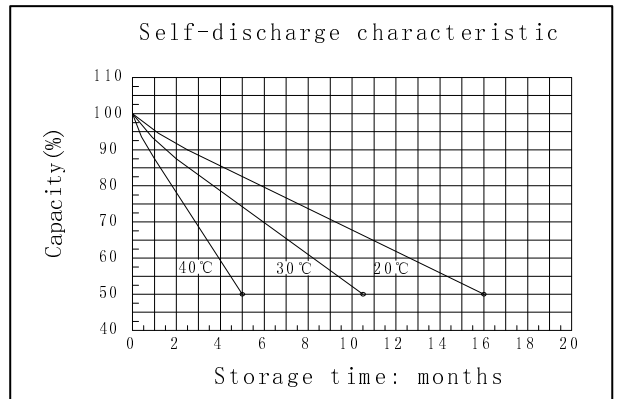
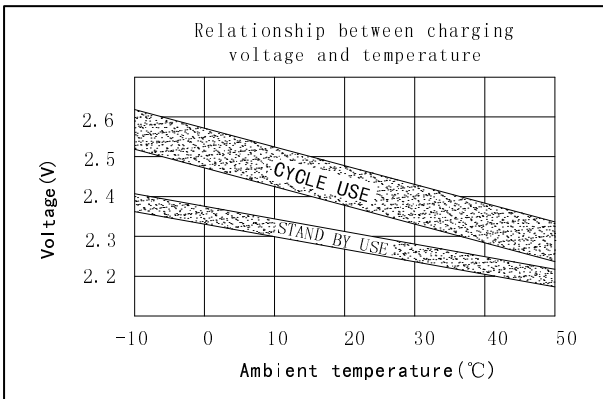
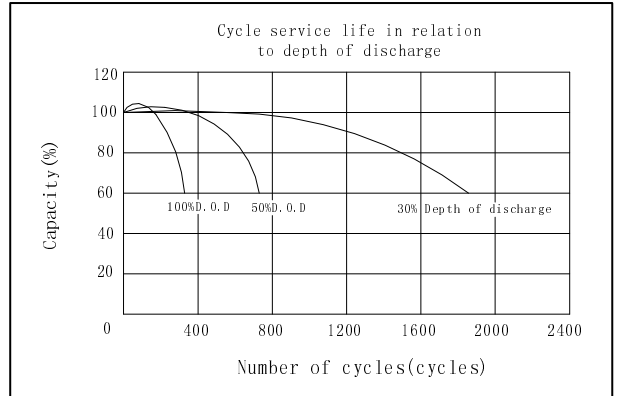
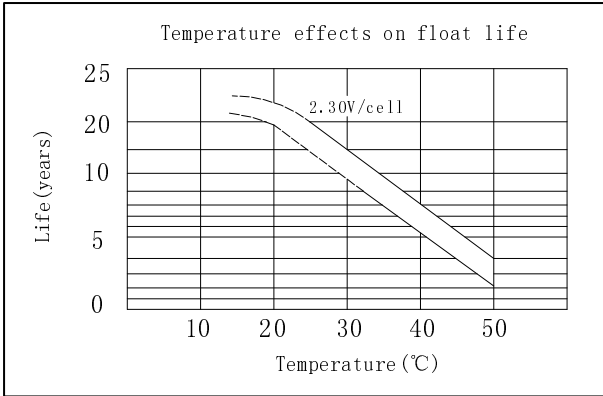
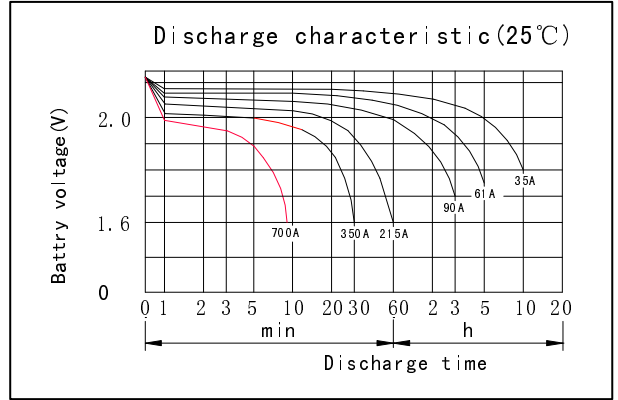
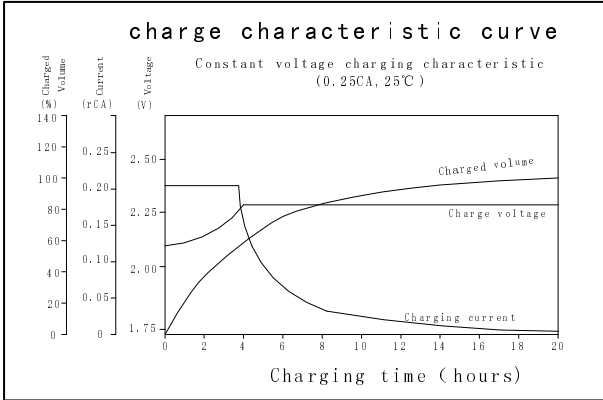

GREAT POWER BATTERY TECHNOLOGY CO.,LTD

Address: Longguan 1st Road, LongHua Town, BaoAn District, Shenzhen, China.
 TEL: 86-755-2900 8403 Fax: 86-755-3386 3366
 Email: info@greatpowerbattery.com Http:// www.greatpowerbattery.com

