



### Perfect union of ViaSolis Glass/Glass modules and Solrif mounting solution

Thanks to the patented photovoltaic in-roof mounting system by Solrif®, it is easy to turn a frameless ViaSolis Glass/Glass module into a solar power generating roof tile; thus, replace conventional roof cover.

Unlike on-roof systems, this roof integrated mounting system is a true alternative to conventional roof covers. More and more leading manufacturers of photovoltaic modules are offering their products with the simple yet proven Solrif®.

The Solrif® mounting system is suitable for various roof types. It can be used in complete or partial photovoltaic roofing, including in combination with solar thermal collectors or roof penetrations (such as skylights, chimneys, etc.). The flexible design options of Solrif® allow a simple and quick installation.

### ADVANTAGES OF PV ROOF INTEGRATION ARE:

- Architectural and aesthetic demands satisfied.
- Roof tiles, slates etc. substituted by PV panels save roofing costs during construction or renovation.
- Particularly suitable for renovation. This will be an important topic in the near future.
- Decreased CO2 emission because tiles are not necessary.
- Less insurance costs, as the system is part of the building



Glass/Glass modules – advanced choice for those who look for durability, safety, efficiency.

## KEY FEATURES



**Quick and fast installation** due to less components for the mounting system.



**Easy and flexible maintenance** – single module pick inside the field is possible. Module based monitoring possible with SolarEdge Technology.



**Aesthetically superior solution.** Full cover for the roof with perfect and aesthetical look in different colours.



**50+ year lifespan.** Edge-sealant protection ensures superior atmospheric and humidity resistance.



**Back glass** instead of plastic ensures durability and robust protection against UV, moisture, ammonia and salt corrosion.



**Higher heat dispersal.** Glass is a better thermal conductor than a plastic back-sheet in standard modules ensuring higher efficiency in hot climates.



**100 % PID free.** Potential induced degradation is eliminated at cell level with special ARC structure and in module level by using PVB lamination foil.



**Wider light spectrum absorbed.** PVB lamination foil utilises the light spectrum starting from 280nm.



## RELIABLE QUALITY

- Positive power tolerance 0/+5 W
- 100% double quality control ensures modules are defect free
- Fully automated production lines
- Designed and manufactured in EU

## MANUFACTURER WARRANTY

- 50-year laminates warranty
- 35-year product warranty
- 35-year linear performance guarantee

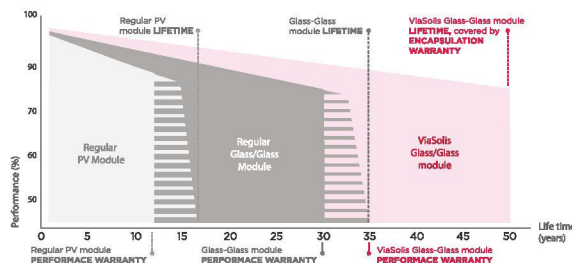

## SOLRIF system options

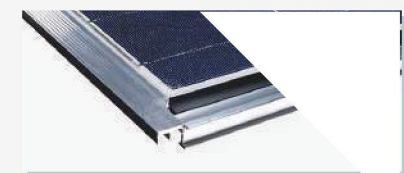

## MECHANICAL PARAMETERS

Cell (mm)	Mono black/Poly blue (156x156)
Weight (kg)	23 (approx.)
Dimensions (LxWxH) (mm)	1723 x 1023 x 17
Cable Cross Section Size (mm <sup>2</sup> ) / Plugs	6/MC4
No. of Cells in the Module	6 (10x6)
Junction Box	Choice of SolarEdge optimizer or Standard J-box
Front / Back Glass (mm)	2,1/2,1
Packaging Configuration	16 per pallet

## WORKING CONDITIONS

Maximum System Voltage	DC 1000V (EU)
Operating Temperature	-40 °C~+85°C
Maximum Current	15A
Maximum Static Load, Front (wind / snow)	10000Pa / 10000Pa
NOCT	43,6°C
Safety Class	II

## ENGINEERING DRAWING

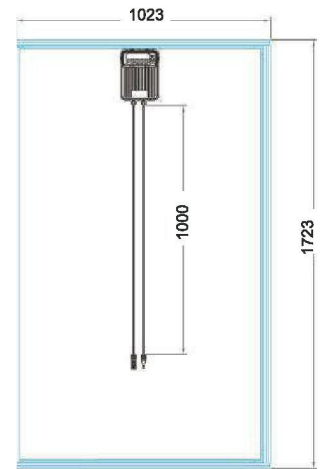

## ELECTRICAL PARAMETERS

TYPE	ViaSolis Solrif 60.P 250	ViaSolis Solrif 60.P 255	ViaSolis Solrif 60.P 260	ViaSolis Solrif 60.M 265	ViaSolis Solrif 60.M 270
Rated Maximum Power at STC (Wp)	250	255	260	265	270
Open Circuit Voltage (Voc/V)	37.57	37.63	37.66	38.43	38.47
Maximum Power Voltage (Vmp/V)	30.14	30.17	30.19	30.78	30.82
Short Circuit Current (Isc/A)	8.87	9.04	9.21	9.12	9.29
Maximum Power Current (Imp/A)	8.30	8.46	8.62	8.61	8.77
Module efficiency [%]	15.08	15.38	15.68	15.98	16.29
Power Tolerance	0/+5 W	0/+5 W	0/+5 W	0/+5 W	0/+5 W
Temperature Coefficient of Isc (dIsc)	+0.05%/°C	+0.05%/°C	+0.05%/°C	+0.0455%/°C	+0.0455%/°C
Temperature Coefficient of Voc (βVoc)	-0.34%/°C	-0.34%/°C	-0.34%/°C	-0.3055%/°C	-0.3055%/°C
Temperature Coefficient of Pmax (γPmp)	-0.42%/°C	-0.42%/°C	-0.42%/°C	-0.3910%/°C	-0.3910%/°C

STC Bestrahlungsstärke 1000 W/m<sup>2</sup>, Modultemperatur 25°C, AM 1,5

### String Lengths (computed automatically by SolarEdge Site Designer)

Module Power		255	260	265	270
MINIMUM string size with SolarEdge inverter	1ph		8		
	3ph		16		
	3ph-MV		18		
MAXIMUM string size with SolarEdge inverter	1ph	20	20	19	19
	3ph	44	43	42	41
	3ph-MV	50	49	48	47
String size with Non-SolarEdge inverter		According to inverter design rules			

### Output Voltages and Currents

Operating Output Voltage when connected to SolarEdge Inverter	5-60	Vdc
Operating Output Voltage when connected to Non-SolarEdge Inverter	5-Voc of module	Vdc
Maximum Output Current when connected to SolarEdge Inverter	15	Adc
Maximum Output Current when connected to Non-SolarEdge Inverter	10	Adc
Output in Standby mode with SolarEdge inverter or with SMI and Non-SolarEdge inverter (when disconnected from inverter or inverter off)	1	Vdc

### Junction Box Standard Compliance

Fire Safety: VDE-AR-E 2100-712:2013-05

PV Junction Box Safety: IEC62109-1 (class II safety, TUV-SUD), UL1741 (TUV-Rheinland & CSA)

PV Junction Box: En50548 (TUV-SUD), UL3730 (TUV-Rheinland & CSA)

## SOLRIF

### Easy Installation

The modules are held by metal clamps that are mounted to the roof battens. This allows for quick and easy installation.

### Optimal Weather-tightness

Frames are shingled from top to bottom and are interlocking left to right much like tiles for optimal weather protection. For roof pitches between 10 and 70 degrees (lower slopes require rain-proof or water-tight substructure).

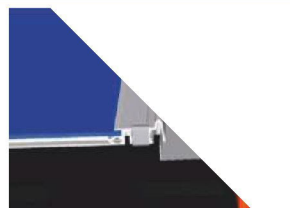







## ADVANTAGES AT A GLANCE

- Substitutes conventional roof cladding
- As weather-tight as a traditionally tiled roof
- Tried and tested in thousands of roofs for more than 10 years
- Higher surface yield due to narrow frame profiles
- Short energy pay-back of just 3 years
- Good ventilation due to sleek frame profile
- Weather-protected cabling
- Easy to service
- Requires no maintenance

Specifications subject to technical changes and tests. Manufacturer reserves the right of final interpretation.

## Advantages of Via Solis Glass/Glass PV module

Conventional PV module	Glass/Glass PV module	Advantages
3,2 mm front glass	 Ultra thin 2 mm front glass	<i>Up to 2 % higher YIELD effected due increased light transmission</i>
EVA bonding	 PVB bonding	<i>Up to 4 % higher YIELD ensured of wider light spectrum utilisation (starts at 280 nm versus 320 nm (EVA))</i>
Frame	 Frameless	<i>Increased YIELD of the module and PV power station due eliminating negative impact of dirt, sand and snow that commonly stopped by the module frame</i>
Heat transfer coefficient 0,36 W/(m <sup>2</sup> ·K)	 Heat transfer coefficient 0,98 W/(m <sup>2</sup> ·K)	<i>3 times higher heat transfer coefficient (inverse of thermal insulation), 3 times better heat dissipation resulting in up to 2 % higher YIELD</i>
Expected life time 15-20 years	 Expected life time 35-50 years	<i>Increased performance in double</i>
Different thermal shrinkage of the lamination materials	 Equal thermal shrinkage of the lamination materials	<i>No cell breakage ensured by tantamount material design. Withstands higher stress coursed by fluctuations of temperature (day/night), heavy loads and strong winds</i>
Open edge	 Thermo-sealing edge isolation	<i>Up to 50 % increased lifetime due to robust protection against UV, moisture, ammonia and salt corrosion.</i>

### SOLAREEDGE

To maximize power generation for PV systems and to prevent modules from malfunctions, solar power harvesting and PV monitoring systems are necessary. ViaSolis PV modules have already an embedded SolarEdge Optimizer which, in combination with SolarEdge inverter and module level monitoring, guarantees up to 25% more energy due to MPP tracking and Module level monitoring. Advantages in combination with Solrif®: Optimum protection of wooden structure against fire. Easy maintenance by module level based monitoring. ViaSolis PV modules with standard junction box are available as well.

### RELIABILITY

ViaSolis Glass/Glass module is the first PV module tested and approved by the Electrosuisse - main Swiss certification body.