

Specifications

Nominal Voltage		12V
Rated capacity (10 hour rate)		60Ah
Dimensions	Length	350±2mm(13.78inch)
	Width	166±2mm(5.54inch)
	Height	179±2mm(7.05inch)
	Total Height	179±2mm(7.05inch)
Approx. Weight		20.5kg(45.1lbs)±3%

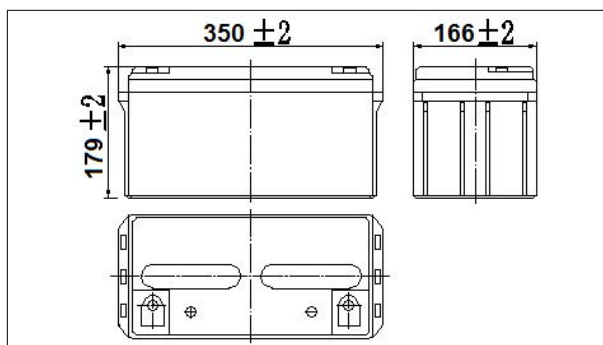

Outer dimensions (mm)



Terminal Type (mm)

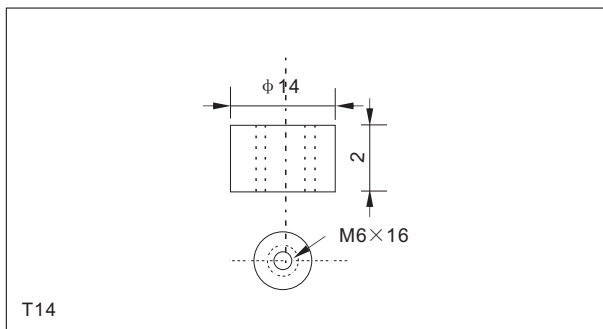

Characteristics

Capacity (25°C)	10HR(10.8V)	60Ah
	3HR(10.8V)	45.9Ah
	1HR(10.5V)	34.5Ah
Terminal type		T14
Internal resistance (Fully charged, 25°C)		Approx. 7mΩ
Capacity affected by temperature (10HR)	40°C	102%
	25°C	100%
	0°C	85%
	-15°C	65%
Self-discharge (25°C)	3month	Remaining Capacity:91%
	6month	Remaining Capacity:82%
	12month	Remaining Capacity:65%
Nominal operating temperature		25°C ±3°C(77°F ±5°F)
Operating temperature range	Discharge	-15°C~50°C(5°F~122°F)
	Charge	-10°C~50°C(14°F~122°F)
	Storage	-20°C~50°C(-4°F~122°F)
Float charging voltage(25°C)		13.50 to 13.80V Temperature compensation: -18mV/°C
Cyclic charging voltage(25°C)		14.50 to 15.00V Temperature compensation: -30mV/°C
Maximum charging current		18A
Terminal material		Copper
Maximum discharge current		600A(5 sec.)
Designed floating life(20°C)		10years

Construction

Component	Positive plate	Negative plate	Container	Cover	Separator	Electrolyte	Safety valve	Terminal
Raw material	Lead dioxide	Lead	ABS	ABS	AGM	Sulfuric acid	Rubber	Copper

Constant Current Discharge Characteristics Unit:A(25°C,77°F)

F.V/Time	10min	15min	30min	60min	2h	3h	4h	5h	8h	10h	20h
9.60V	131	101	60.3	37.1	21.9	15.8	12.6	10.8	7.41	6.11	3.24
9.90V	127	98.4	59.1	36.5	21.8	15.7	12.5	10.7	7.36	6.10	3.23
10.2V	122	94.8	57.3	35.6	21.6	15.6	12.4	10.6	7.31	6.08	3.22
10.5V	116	91.5	55.9	34.5	21.3	15.5	12.4	10.6	7.26	6.04	3.20
10.8V	110	86.7	53.8	33.4	20.7	15.3	12.0	10.2	7.04	6.00	3.18

Constant Power Discharge Characteristics Unit:W(25°C,77°F)

F.V/Time	10min	15min	30min	60min	2h	3h	4h	5h	8h	10h	20h
9.60V	1413	1107	677	423	254	186	148	127	88.0	72.9	38.8
9.90V	1370	1080	663	416	252	185	147	127	87.5	72.8	38.8
10.2V	1314	1040	643	406	250	183	146	126	86.9	72.6	38.7
10.5V	1257	1005	627	393	246	182	145	125	86.2	72.1	38.4
10.8V	1187	952	604	380	240	177	141	121	83.7	71.6	38.2

Note: The above characteristics data can be obtained within three charge or discharge cycles.

● Discharge characteristics(25°C)

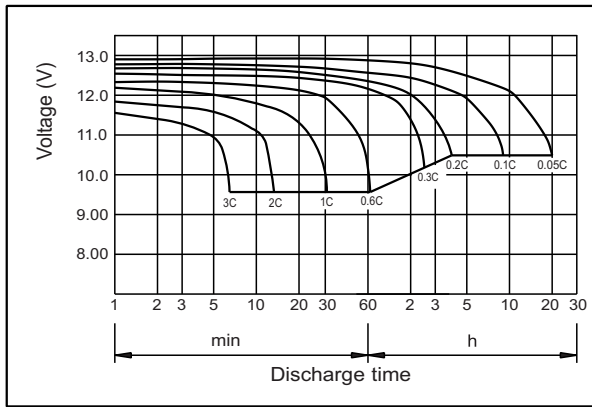

● Charging characteristics (25°C)

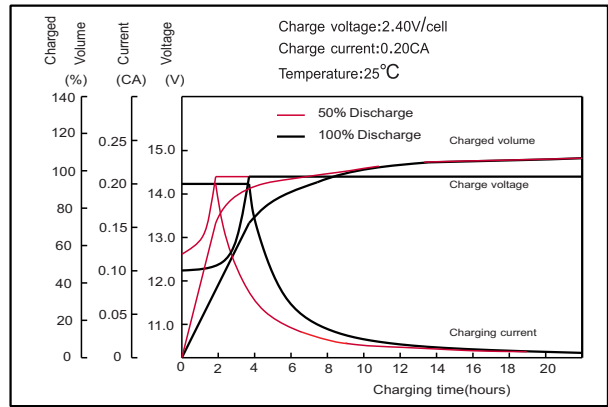

● Temperature effects on Capacity

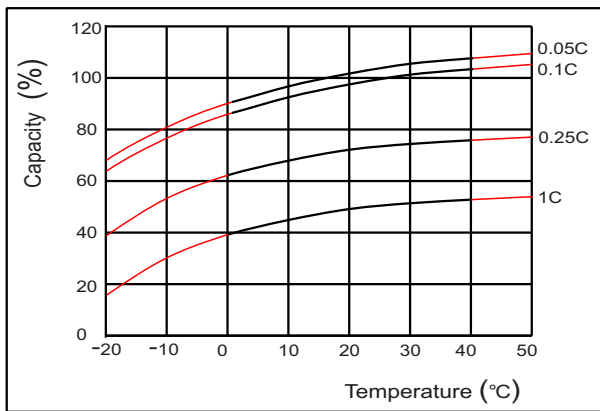

● Self-discharge characteristics

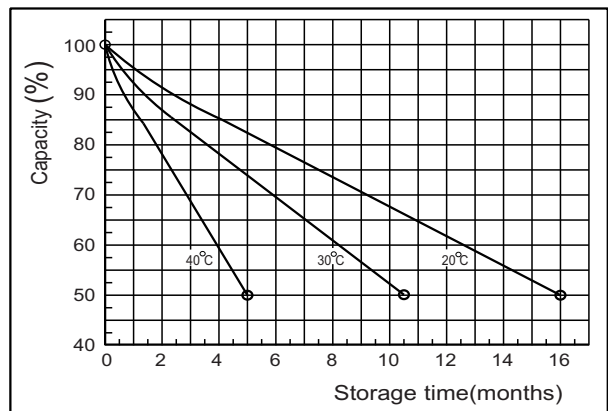

● Floating life on Temperature

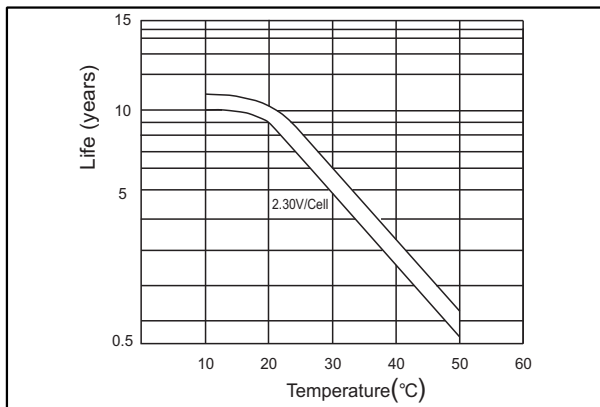

● Cycle life on D.O.D (25°C)

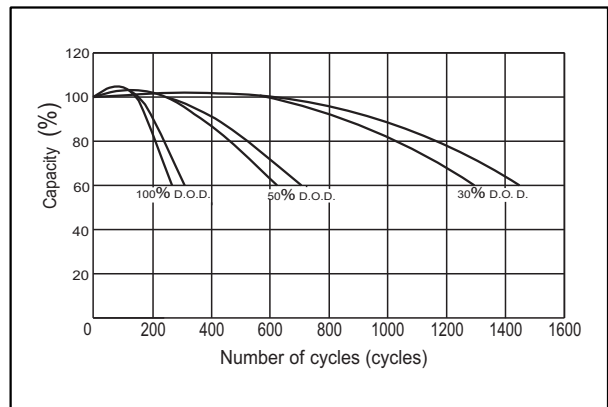

● The relationship for OCV and Capacity (25°C)

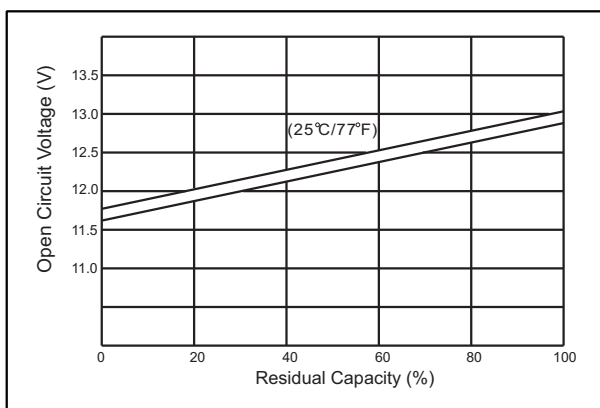

● The relationship for Charging voltage and Temperature

