



Shenzhen CBT Enterprise Co.,Ltd

SKU: VB030 | VOLTAGE: 12.8 V | CAPACITY: 100AH | ENERGY: 1200 WH

ELECTRICAL SPECIFICATIONS

Nominal Voltage	12.8 V
Nominal Capacity	100 Ah
Resistance	≤10 mΩ
Efficiency	99%
Self Discharge	<3% per Month
Cell Type - Chemistry	LiFePO4

CHARGING SPECIFICATIONS

Standard Charge Current	≤ 50 A
Max Charge Current	100A
Float Charge Voltage	13.8 ± 0.2 V
Recommended Charge Voltage	14.4 V - 14.6 V
BMS Charge Protection Voltage	14.8 V
Reconnect Voltage	14.4 V
Balancing Current	30 mA

DIMENSIONAL SPECIFICATIONS

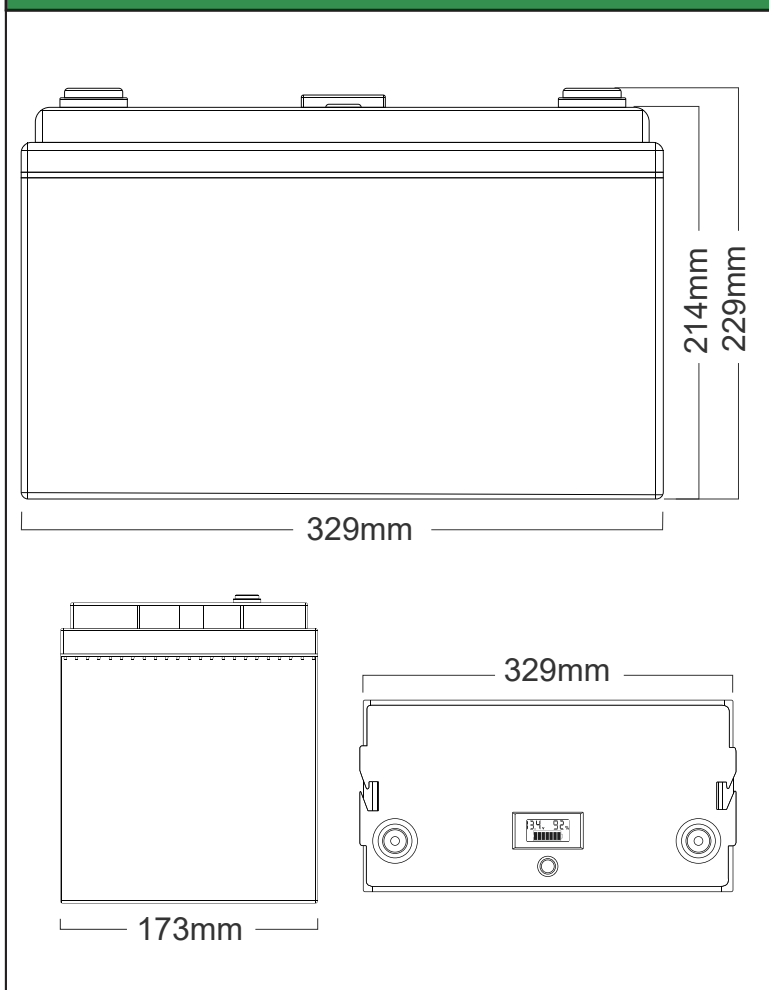

DISCHARGING SPECIFICATIONS

Standard Discharge Current	50 A
Max Continuous Discharge Current	100 A
Max Discharge Current	300 A Für 10 S
Peak Discharge Current	350 A Für 5 S
BMS Discharge Protection Voltage	10 V ± 0.2 V
Reconnect Voltage	11.2 V ± 0.04 V
Short Circuit Protection	250 μs

TEMPERATURE SPECIFICATIONS

Discharge Temperature	-20 °C - 60 °C
Charge Temperature	0 °C - 55 °C
BMS High Temperature Cut-Off	65 °C
Reconnect Temperature	55 °C

MECHANICAL SPECIFICATIONS

Dimensions (L x W x H)	329*173*229 mm
Weight	10.0 kg
Terminal Type	M8
Shell Material	ABS
IP Rating	IP65



www.cbtpower.com

CE | MSDS | RoHS | FC | UN38.3

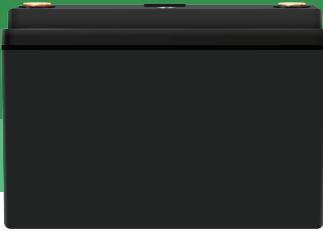

SKU: VB030 | VOLTAGE: 12.8 V | CAPACITY: 100 AH | ENERGY: 1200 WH

DISCHARGE CURVE AT DIFFERENT RATES (25°C)

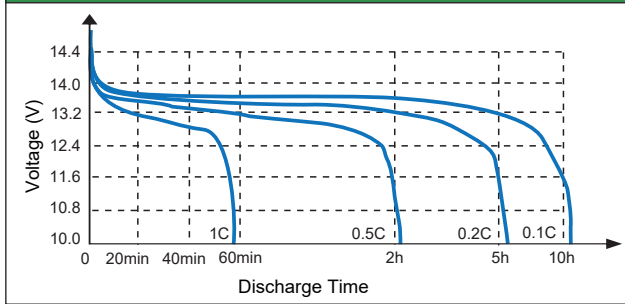

STATE OF CHARGE CURVE (0.5C, 25°C)

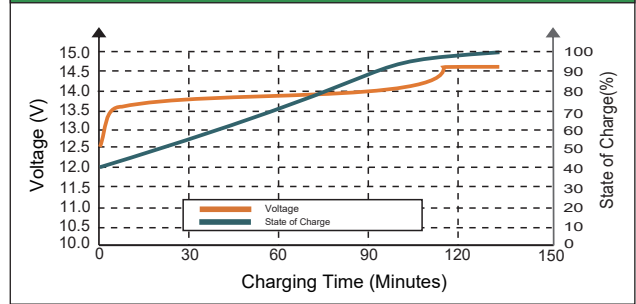

CHARGING CHARACTERISTICS (0.5C, 25°C)

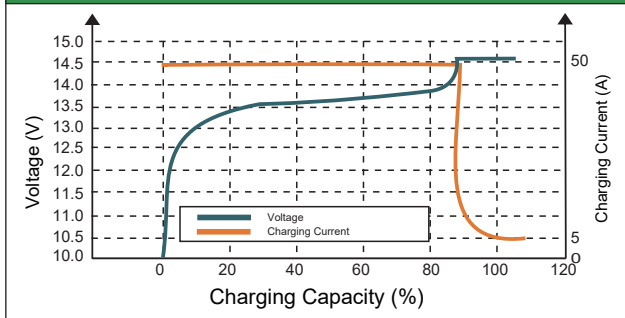

DIFFERENT TEMPERATURE DISCHARGE CURVE (0.5C)

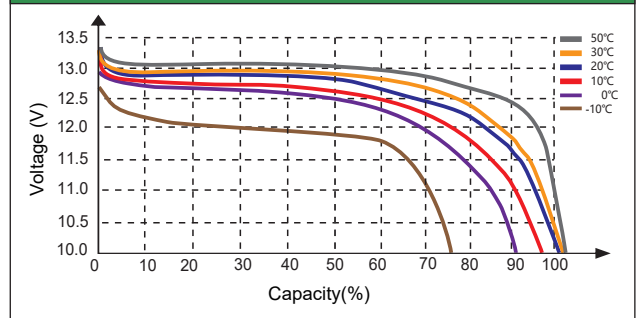

DIFFERENT TEMPERATURE SELF-DISCHARGE CURVE

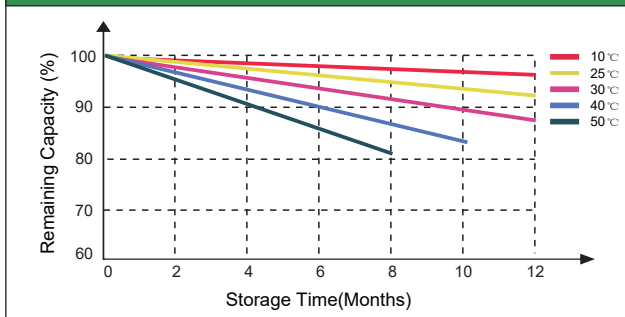

DIFFERENT DOD DISCHARGE CYCLE LIFE CURVE

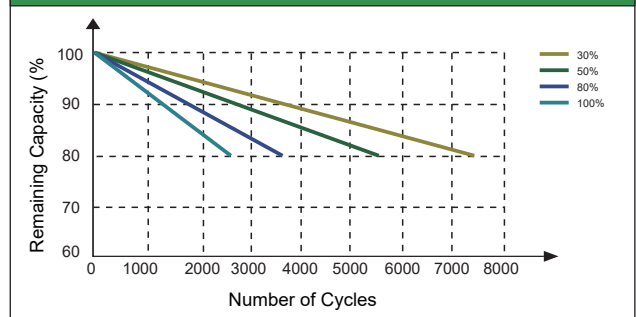

FEATURE LIFEPO4 BATTERY



HIGH TEMPERATURE RESISTANCE

The peak value of lithium iron phosphate electric heating can reach 350°C-500°C, while lithium manganate and cobalt acid lithium is only around 200°C, with a wide operating temperature range (-20°C-75°C).



BMS CONTROL

The battery management system monitors and adapts to battery conditions to maximize performance and safety.



HIGH SECURITY

The P-O bond in the lithium iron phosphate crystal is stable and difficult to decompose. Even at high temperature or overcharge, it will not collapse and generate heat like lithium cobalt oxide or form strong oxidizing substances, so it has good safety.



ENVIRONMENTAL PROTECTION

Lithium iron phosphate batteries are generally considered to be free of any heavy metals and rare metals (the nickel-hydrogen battery requires rare metals), non-toxic (SGS certification), pollution-free and meets European RoHS regulations, and is an absolute green battery.



LONG CYCLE LIFE

At 80% depth of discharge, the number of cycles exceeds 3,000, and a 2-year warranty is provided.



LIGHT WEIGHT

The volume of a LiFePO₄ battery with the same specification and capacity is the volume of a lead-acid battery, the weight is 1/3 of the lead-acid battery. Allowing for simple installation and transportation.