

72 CELL POLYCRYSTALLINE MODULE

330W-350W POWER OUTPUT RANGE

18.04% MAXIMUM EFFICIENCY

0~+5W POSITIVE POWER TOLERANCE

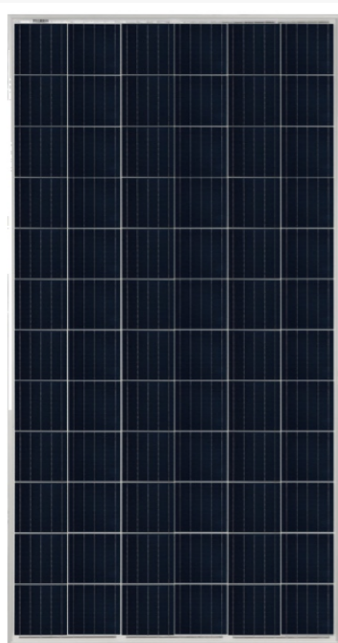

ISO9001:2015 Quality management systems
ISO14001: 2015 Quality management systems
OHSAS18001: 2018 Occupational health and safety management systems

IEC61215, IEC61730, UL1703 certified product

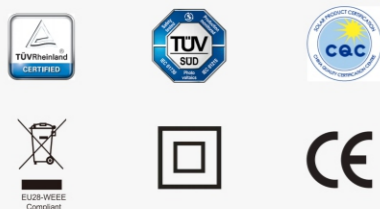

- Ideal for large scale installations**
 - High power footprint reduces installation time & BOS costs
- One of the industry's most trusted modules**
 - Field proven performance
 - Juli NewEnergy's financial solidity consistently confirmed by banks and investors
- Highly reliable due to stringent quality control**
 - Over 30 in-house tests(UV,HF,and many more)
 - In-house testing goes well beyond certification requirements
- Certified to withstand challenging environmental conditions**
 - 2400 Pa wind load
 - 5400 Pa snow load
- High conversion efficiency**
 - Due to top quality wafers
 - Advanced cell technology
- PID and snail trails free**
 - Selected encapsulating material
 - Stringent production process control
- Excellent performance under low irradiance**
 - Special cell process
- Additional yield and easy maintenance**
 - Highly transparent self-cleaning glass

LINEAR PERFORMANCE WARRANTY

- 12-year product warranty
- 25-year linear power output warranty **0.7% Annual Degradation Over 25 years**

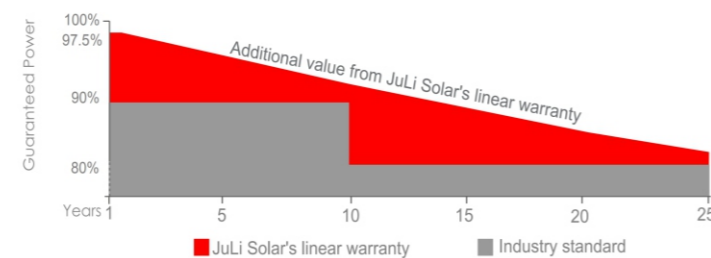

TECHNICAL PARAMETERS

DIMENSIONS OF PV MODULE(mm)

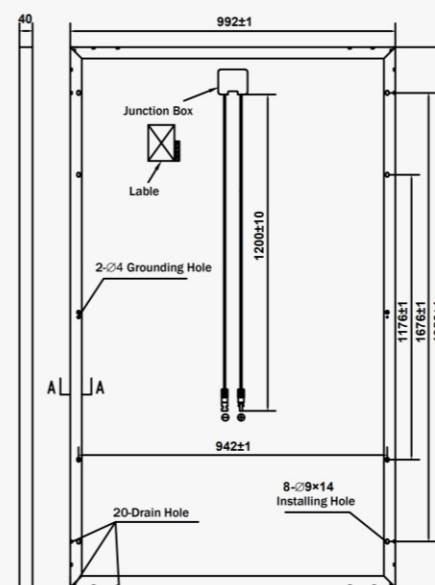

Back View

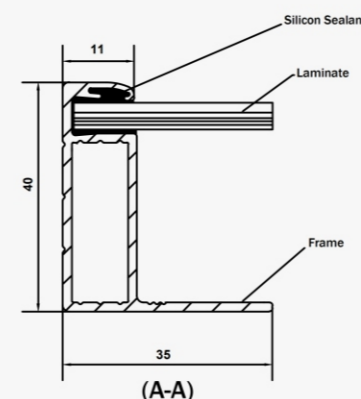

(A-A)

I-V CURVES OF PV MODULE(335W)

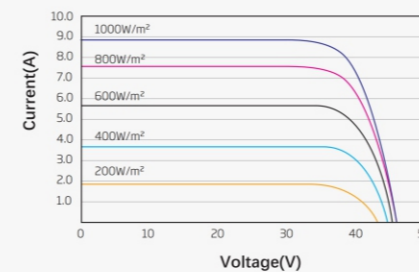

P-V CURVES OF PV MODULE(335W)

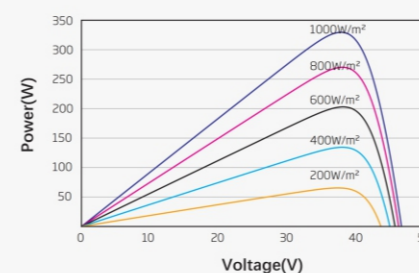

MECHANICAL DATA

Module Dimensions	1956 × 992 × 40mm
Weight	22.0kg
Cell	Polycrystal 157mm x 157mm
Glass	3.2mm AR tempered
Frame	Anodized aluminum alloy
Junction Box	IP67
Cables	4.0 mm ² , 1200mm (Customized Length)
Connector	MC4 compatible
Wind/Snow Load	2400 Pa /5400 Pa

ELECTRICAL DATA (STC)

Module Type (JLS72P)	350W	345W	340W	335W	330W
	STC	STC	STC	STC	STC
Peak Power (P _{max})	350W	345W	340W	335W	330W
Open Circuit Voltage (V _{oc})	46.8V	46.6V	46.4V	46.2V	46.0V
Short Circuit Current(I _{sc})	9.54A	9.48A	9.42A	9.36A	9.30A
Maximum Power Voltage(V _{mp})	38.6V	38.3V	38.1V	37.8V	37.6V
Maximum Power Current (I _{mp})	9.07A	9.01A	8.92A	8.86A	8.84A
Module Efficiency	18.04%	17.78%	17.52%	17.26%	17.01%
Power Tolerance	0~+5W				
Maximum System Voltage	DC1000V/DC 1500V				
Max Series Fuse Rating	15A				

STC:Irradiance 1000W/m²,25°C,AM1.5

TEMPERATURE RATINGS

Temperature Coefficient of P _{max}	-0.40%/°C
Temperature Coefficient of V _{oc}	-0.33%/°C
Temperature Coefficient of I _{sc}	0.06%/°C
Operational Temperature	-40~+85°C
NOCT(Nominal Operating Cell Temperature)	45 ± 2°C

PACKAGING CONFIGURATION

Container	20GP	40HQ
Quantity/pallet	27	27
Pallets/container	10	24
Quantity/container	270	692

Specifications are subject to change without prior notice

