

# THMS2000

## 2000WATT / 4000WATT PEAK

### POWERS UP TO 20AMPS



THE CHOICE FOR PERFORMANCE

THMS2000



### MODIFIED SINE WAVE INVERTER









THOR inverters have set the standard with the way you deal with your mobile power needs, providing AC electricity. A power inverter converts the DC electricity from batteries into everyday AC power.

With a THOR inverter you won't need to rely on a generator to have power for tools, electronics or any AC power needs. THOR inverters are efficient and dependable and come in numerous sizes and power ranges to meet your mobile power demands.

### Design Features

- 2000 Watts Continuous Output
- 4000 Watt High Surge Power
- 4 x GFCI Protected 120 Volt AC Outlets
- Compatible with all THOR Remote Controls
- USB Charging Port
- Rugged Aluminum Design
- Compatible with Appliances <= 2000 watts
- Digital Display
- Easy Installation

### Accessories

 <b>TH-002</b>	 <b>TH-RC</b>	 <b>TH-IRC</b>
<b>Remote Controls</b>		
 <b>Cables</b> (1/0 - 10 Feet) THCBL10F1/0	 <b>Fuses</b> THANLFB200 200 Amp Fuse	 <b>Isolators</b> THI-200 200 Amp Isolator
 <b>AC Extension</b> TH-EXT	 <b>Low Voltage Disconnect</b> TH-LVD	 <b>Transfer Switch</b> THTS30

2000 WATT MODIFIED SINE WAVE INVERTER WITH USB

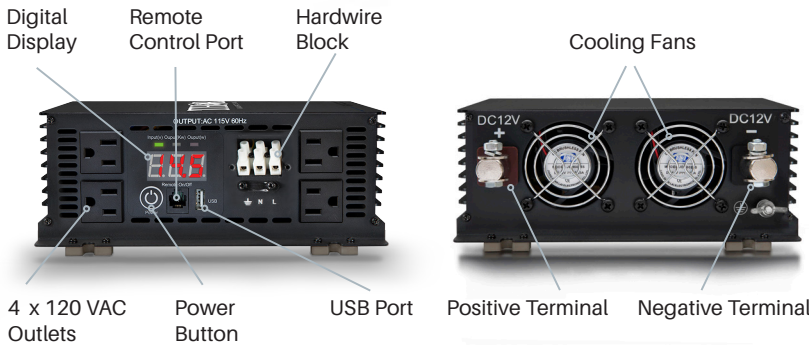

### Specifications

DC Input Voltage	12 Vdc
DC Input Voltage range	10.5 - 16.5 +/- .5
Maximum Output Current	20 Amps
Continuous Output Power	2000 Watts
Max Output for 10 Min - 10% over inverters rated continuous wattage	2200 Watts
Surge Output Power	4000 Watts
Peak Efficiency	85-90%
DC Input Connections	Bolt Down Lugs
AC Output Connection	4 x GFCI Protected 120 Volt AC outlets
Terminal Block for Hardwiring	Yes
Display	Digital Display With Error Codes



### THOR MANUFACTURING

7050 W. Palmetto Park Rd. Suite 15  
Boca Raton, FL

Phone: (866) 955-THOR  
(866) 955-8467

Mail: sales@thorpowerproducts.com  
Web: www.thorinverters.com

## Dimensions

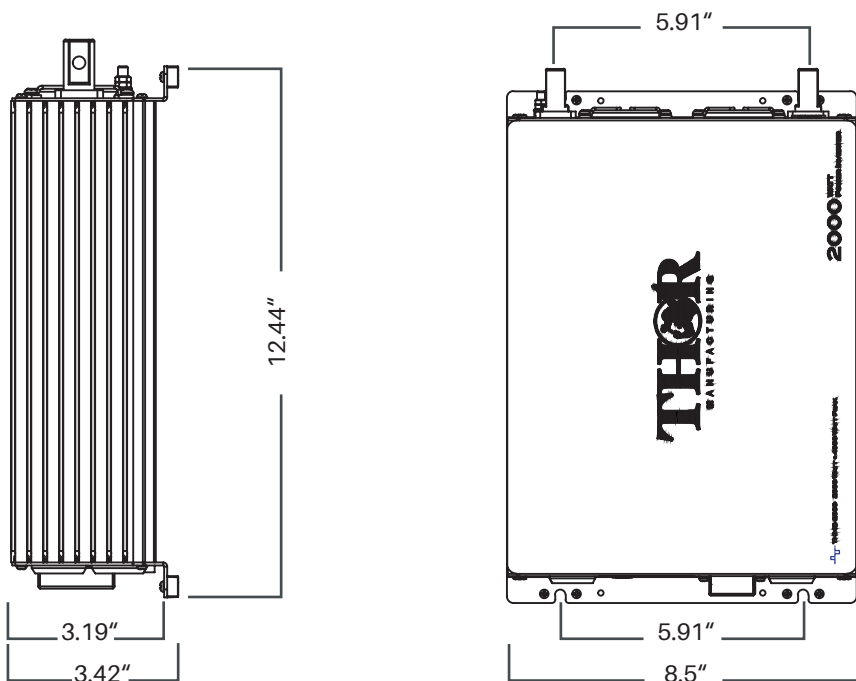

Dimensions: 13.77L x 8.5W x 3.34"H

Weight: 10.75 Lbs

UPC Code: 853003006278

Warranty: 1 Year

## Installation Diagrams

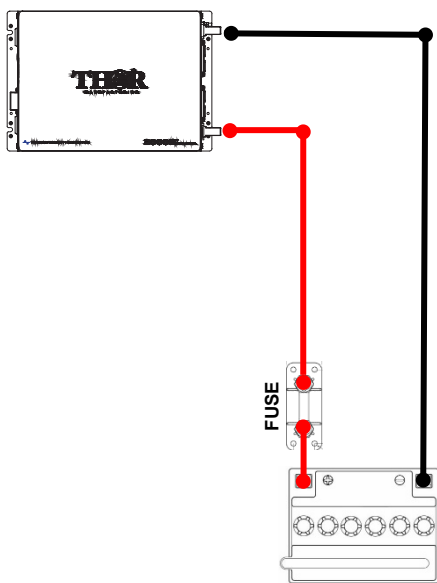

STAND ALONE OR IN VEHICLE

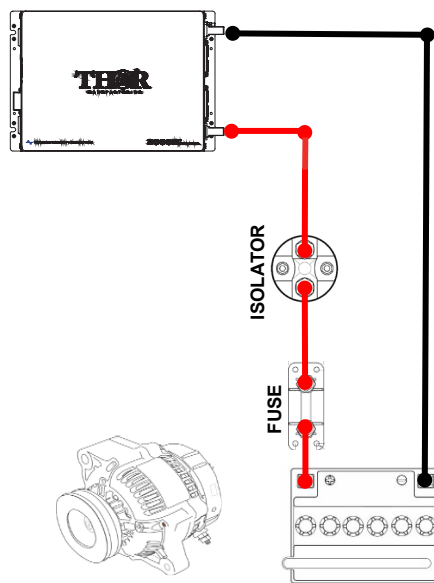

VEHICLE IGNITION CONTROLLED

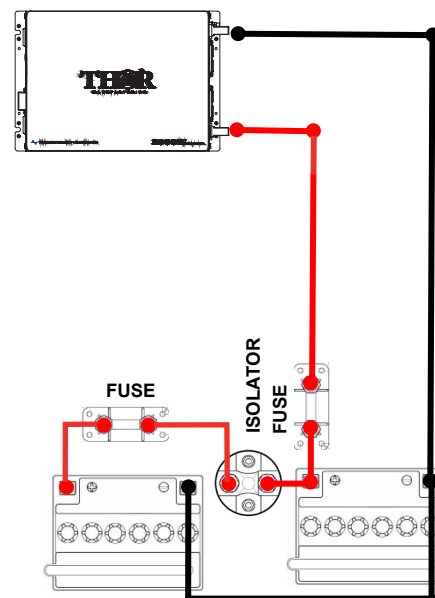

DUAL BATTERY INSTALLATION  
ISOLATING VEHICLE BATTERY

Inverters are also available as Installation Kits (including the inverter)

THMS2000-KIT 2



THMS2000-KIT 3



THMS2000-PRO KIT



THMS2000-RV KIT

